

Experience the revolution...

SKYHUB Office Partition Systems are designed to meet the particular needs of office, corporate, commercial, healthcare and banking. It provides the ultimate flexibility in design.

Bigger better design

2023 - 2024



SKYHUB Office Partition Systems are designed to meet the particular needs of office, corporate, commercial, healthcare and banking. It provides the ultimate flexibility in design.

SKYHUB Office Partition Systems are engineered for speed and ease of installation. The unique extrusion profiles have been designed to be configured in an infinite number of combinations and incorporated with almost any other material or finish.

The profiles are usually cut on site, making it possible to incorporate last minute changes in layout or to adjust to site conditions without affecting the cost or project completion dates.

Our commitment is to provide regular introduction of new designs and profiles with customer satisfaction. We are pleased to work with architects and designers to customize profiles in order to realize their design concepts. Each of our partitioning systems have been developed to be fully compatible with a number of different door types, providing with the flexibility to design a workable space that is both practical and stylish.

SKYHUB Hardware is a range of premium door hardware. Our products are cleverly designed and easy to understand, enabling designers to fully express their creativity without the constraints of factory tooling, moulding and pre-fabrication lead time.

All SKYHUB products come in a wide range of styles, finishes and functions that complement and enhance every project.

SKYHUB has several systems that provide both design creativity and flexibility at the same time. Our full time design staff provides a comprehensive CAD support service and any other tender documentation upon request. Our project and technical staff is available at any given time, at any location, to provide technical support service.



Our Mission

To serve our customers with Innovative & Futuristic product, providing privacy, aesthetics and value to the work place with compassion, dedication and honesty.

Our Vision

TO BE THE MOST PREFERRED BRAND FOR GLASS PARTITIONING AND RELATED PRODUCTS WITH

- LATEST TECHNOLOGY
- INNOVATIVE DESIGN
- VALUE ENGINEERING

Values

- HONESTY IN COMMITMENT AND WORK
- INTEGRITY IN SERVICE
- ENVIRONMENT PROTECTION ALONG WITH OUR PROFESSIONAL COMMITMENTS



WHY SKYHUB ?

SKYHUB today has become synonymous with the Glass Partitions. The reasons are Loud & Simple.

PROFESSION with PASSION

For SKYHUB, servicing the customers is a unique blend of "PASSION with PROFESSION"

- It's not merely a business transaction but a passion to service our industry with the best intentions and ensuring the smile on our customer's face that makes us stand apart in the crowd

FASTEST DELIVERY & EXECUTION

- SKYHUB revolutionized the way projects were handled
- With a ready stock of 1.5 lacs at our warehouse, we deliver the fastest for any project
- We believe delivering in days while others take weeks !!
- The ready stock allows our clients to make last minute changes in design without worrying about the lead time. We help boost your creativity !!

WIDEST REACH

- Our Pan India presence, with offices in all key locations, ensures our reach is the widest
- A unique mix of "Youth and Experience" makes our team the best in its segment
- With a total strength of 148 people we are one of the largest employers in our field

PRODUCTS & INNOVATIONS

- SKYHUB has the widest range of products that caters to ALL & SUNDRY
- Our in-house design team makes it possible for us to cater to almost any design and finish needs, as and when required
- The founders come from a very strong hardware background and hence have designed our products to be very flexible
- Our products are innovative and compatible to almost all the dependent accessories

VALUE FOR MONEY

- SKYHUB values your trust and the money that you put in our products to ensure that you get the best of products in the most competitive price
- We firmly believe in making a win-win situation
- The long list of our satisfied and repeat customers are a witness to this

01.



Concept

Here your design is shared with SKYHUB team so that we can advise on technical aspects. Our vision is to facilitate the successful completion with timely execution of projects.

02.



Design

With around a decade of experience, SKYHUB strives to design products which have a purpose and deliver exceptional results. Having an in-house CAD team, all products are aesthetically designed and are technically acceptable, to turn your dreams into reality.

03.



Manufacturing

Innovation being the core value for striving excellence, SKYHUB manufactures premium products with architectural choice products in India. A dedicated team of R&D department, product specialists and support staff work across for a single cause result.

04.



Installation

SKYHUB has an in-house team as well as approved partners PAN-INDIA. The team is well trained and are self-experienced with proper training to perform small scale as well as big projects coming its way. Project Managers ensure the responsibility of completion along with site supervisors.

05.



Completion

SKYHUB continues to provide customer service for any changes, as and when required at the site. After the execution, the beautiful completed site gives us a sign of relief as well as assured repeat business. After all, it's a continuous process and SKYHUB strives to hit the right note every time a project is completed.



HOW CAN WE SOLVE?

Acoustics: Absorb, Block or Cover

There are three methods of dealing with sound, commonly referred to as the ABC's. Sound can be Absorbed, it can be Blocked or redirected and it can be Covered. The method chosen depends on the final goal of the project.

Sound should be absorbed when the goal is to keep it within the room from reverberating or echoing. If a room has hard surfaces that reflect sound, it will take a long time for the sound level to diminish to a point that it is inaudible. This is most noticeable in an empty room with hard walls, floors and ceilings. You can hear the sounds bouncing around the room. Installing sound absorbing materials such as carpet, acoustic ceiling tiles or fabric covered panels will reduce the reverberation by absorbing the sound. Noise Reduction Coefficient is used for rating a material's ability to absorb sound.

If the goal is to keep the sound within a space, for privacy or other reasons, the sound should be blocked. This can be combined with absorption so that the reverberation in the space is reduced. Blocking sound is generally accomplished by reducing short circuits between two spaces. Common air space is the FIRST path that sound uses and hence this needs to be explored first. If you have a 5% air gap in any kind of a noise barrier, 90% of sound leaks through that air space. Some common features include HVAC ducts or grilles, back-to-back outlets, pipes that pass through a space, partitions that stop above the ceiling but do not extend to the structural deck above. Adding mass to the walls will help block the sound. For instance, a concrete wall blocks sound better than a stud wall. Additional layers of gypsum wall board and insulation in the wall cavity will also help block the sound.

Sound can also be covered to help maintain speech privacy. This is most noticeable in an office environment when the forced air system is turned off. The idea is to provide just a bit of background noise to make nearby conversations unintelligible; the conversation is still there, but the quiet hum of the noise (soft music) masks it.



Acoustic Partition Specification

Why is it required?

An office is the centre of communication, thinking & collaboration. Any unwanted noise within an office is a major distraction and is a reason for employees not being able to achieve optimum productivity. Soundproofing is a necessity for offices, because apart from the noise within office interiors, there is a huge problem of unwanted noise from the exteriors such as traffic, construction, etc. which have the same unpleasant effect. The soundproof offices help in noise cancellation of this unwanted noise which intrudes the 'Thinking Space' of the employees.

Similarly, besides noise reduction, at times it is required to prevent certain discussions from being heard outside a cabin or a conference room. Our state-of-the-art Acoustic Office Glass Partitions make sure that peace and tranquillity within the office is maintained, and that the important discussions remain confidential.

Leakage of sounds comes from three common places;

a - Common air space (Ceiling), b - Mass & Density (Walls), c - Hard surface (Floor)

Poor Acoustic

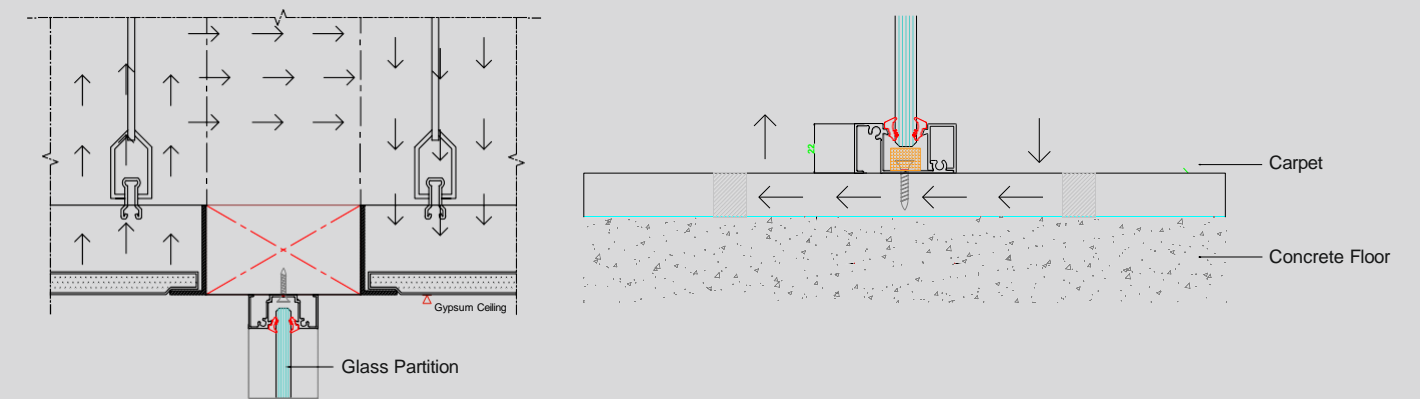

Good Acoustic

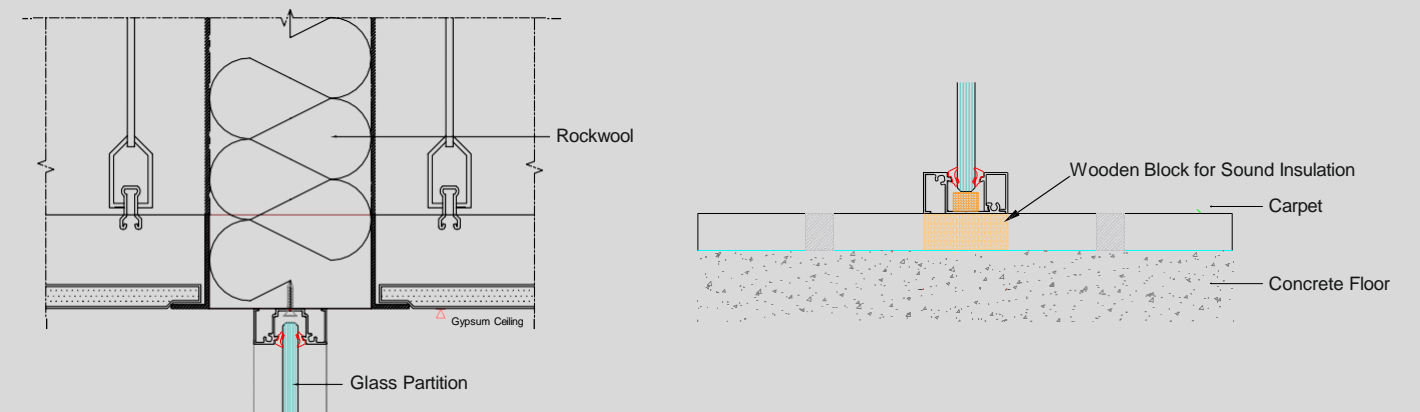



CONTENT

OPTUNIA 25 25mm x 25mm	01
CANNA 45 45mm x 25mm	07
MAPLE 100 100mm x 25mm,	15
BEL 100 DG 100mm x 25mm	23
STILE 60 60mm X 35mm	31
STILE 75 75mm X 45mm	33
STICKON SERIES	35
SKYHUB TECHNICAL PORTAL	39
SKY TELESCOPE SYSTEM 45mm x 16mm	41
SKY SYNCHRO SYSTEM 45mm x 16mm	43
SKY SHOWER CUBICAL 45mm x 16mm	45
ACCESSORIES	47

OPTUNIA 25

25mm x 25mm (single glaze)

CONTEMPORARY WORKING SPACES WITH MINIMALISTIC APPROACH

OPTUNIA 25 series Demountable Architectural Office Partitions can be equipped with strong acoustic insulation, for more relaxing atmosphere within the large office spaces, with minimal section visibility. Multiple options of solid door or tempered glass can be created, which can be installed along with the selection of door frames.

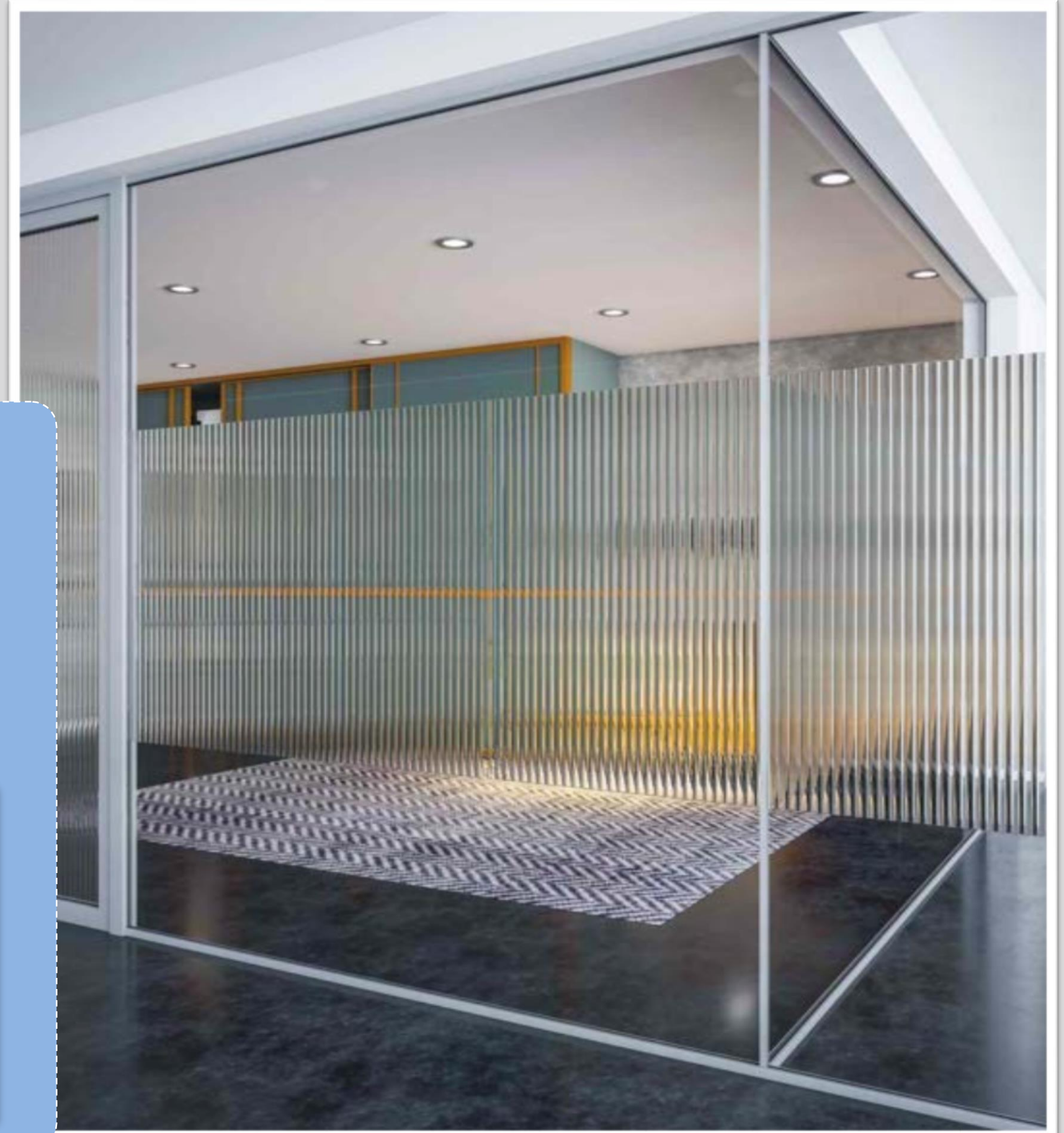
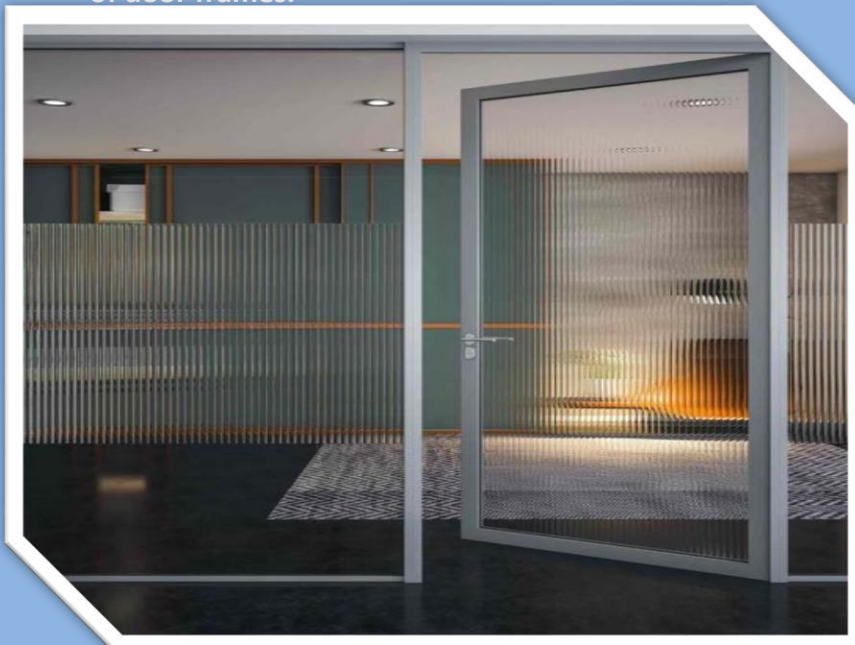

OPTUNIA 25

25mm x 25mm (single glaze)

Technical Details

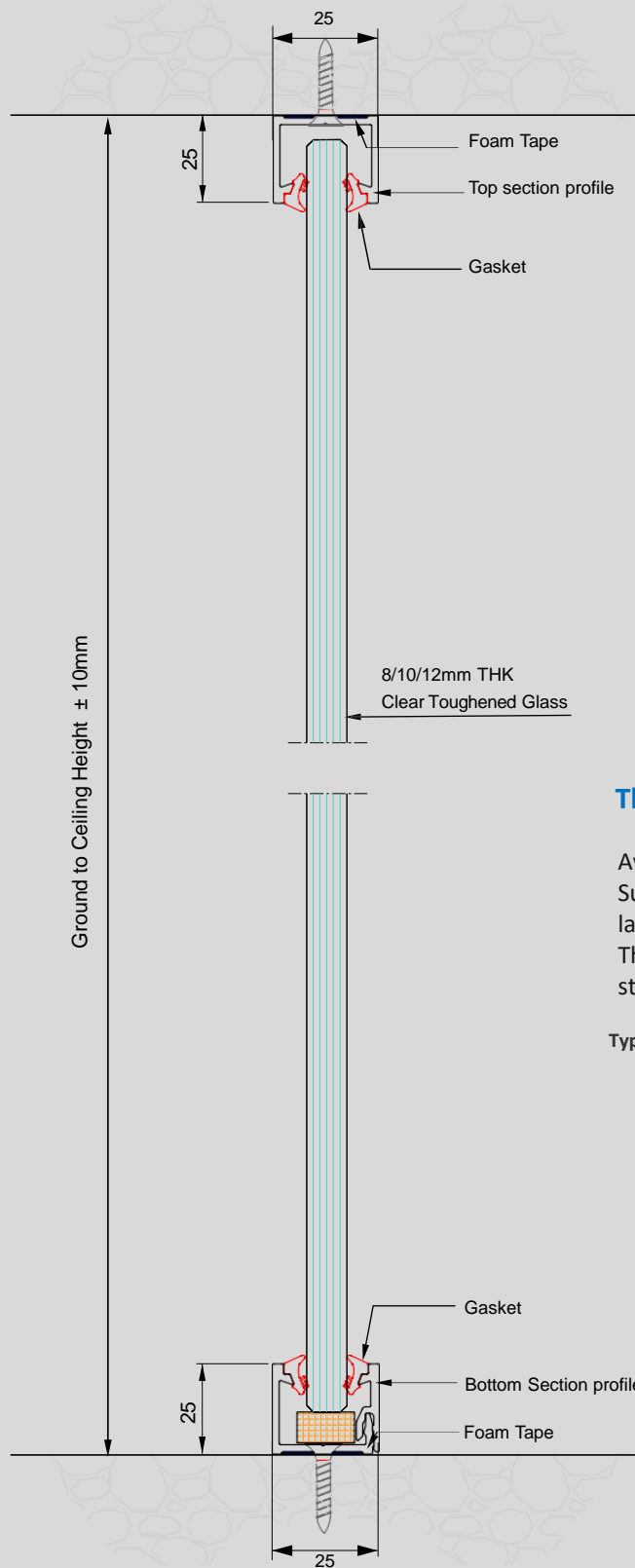

Single Glazed Partition - 25mm x 25mm

These are the various options for joining glass at I, L & T junctions

Available in Aluminium as well as transparent plexi dry joints.
 Suitable for 10mm / 12mm toughened glass as well as 10.52mm / 12.52mm laminated glass.
 The profiles feature a double-sided adhesive tape that guarantee perfect structural union and sound insulation.

Type 1 - Aluminium Joining

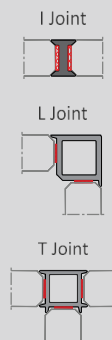

Type 2 - Plexidry Flush Joining



Type 3 - Plexidry Overlap Joining

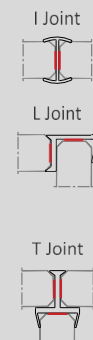

OPTUNIA 25

25mm x 25mm (single glaze)

Sophisticated Architectural Design Options



OPTUNIA 25

25mm x 25mm (single glaze)

Technical Details

CONTEMPORARY WORKING SPACE WITH MINIMALISTIC APPROACH

OPTUNIA 25 Series Demountable Architectural Office Partitions can be equipped with strong acoustic insulation, for more relaxing atmosphere within the large office spaces, with minimal section visibility. Multiple options of solid door or tempered glass can be created, which can be installed along with the selection of door frames.

Features

- Standard Section : 25mm x 25mm
- Slim in design, the standard partition suite can be used with any stud thickness
- Suitable for 8mm / 10mm / 12mm toughened glass
- Single door frame sizes to allow for flush door 35mm
- Partition height can be offered up to 3000mm
- Single glazed systems
- Sound insulation capacity of 30 - 32 dB

Door options

- Frame less glass, Stile glaze door, Timber or Sliding door system

Soild doors

- Timber doors can be of 44mm solid core in choice of veneers*

Door frames

- Aluminium full height up to 3000mm, doors are mounted on either of the hinges, pivots or sliding tracks. A range of Ironmongery can be supplied and incorporated with OPTUNIA 25 series

Size limits

- SKYHUB OPTUNIA is designed for installation in areas up to nominal vertical panel size of 3000mm x 1200mm

Finish

- All exposed aluminium sections are anodized aluminium finish with 6063 T6 Grade

Assembly Characteristics

Glazed panels are hung onto a site installed framework of recessed head, side walls and base channels, studs and transoms. Base tracks have a snap in profile for better installation of glass into section using beads made of silicone gel material and choice of junctions available. Assembly jig supplied ensures the speed accuracy of the installation and correct alignments of panel. All panels can be removed independently of each other allowing replacement or variation at any time after initial installation.

Available in two colors



Black Silver

OPTUNIA 25

25mm x 25mm (single glaze)



CANNA 45

45mm x 25mm (single glaze)

Relaxing atmosphere office space

The CANNA 45 Office Partition is a superior lightweight profile system. It is based on a 45mm x 25mm glazing seal and bead with a selection of door frame options. SKYHUB 45 frames provide an elegant and cost effective design solution.

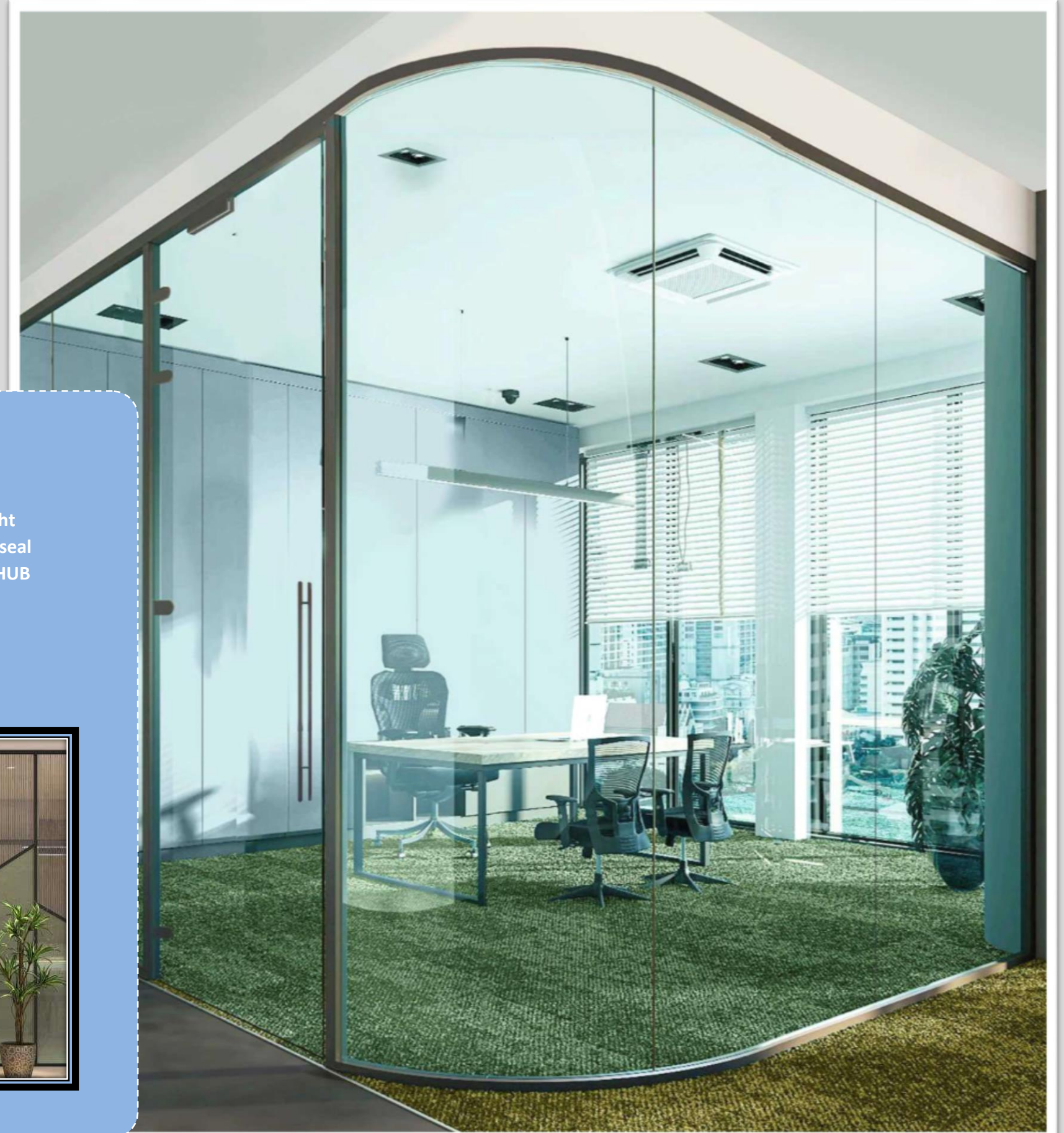

CANNA 45

45mm x 25mm (single glaze)

CANNA 45

45mm x 25mm (single glaze)

Technical Details

Contemporary working spaces with focus on glass

The CANNA 45 office partition is a superior lightweight profile system. It is based on a 45mm x 25mm glazing seal and bead with a selection of door frame options. CANNA 45 frames provide an elegant and cost effective solution.

Features

- Standard track section : 45mm x 25mm
- Slim in design, the standard partition suite can be used with any stud thickness
- Suitable for 10mm / 12mm toughened glass as well as 10.52mm / 12.52mm laminated glass
- Single door frame sizes to allow for flush door 35mm
- Partition height can be offered up to 3000mm
- Single glazed systems
- Sound insulation capacity of 28 - 32 dB

Door Options

- Frame less glass, Stile glaze door, Timber or Sliding door system

Solid Doors

- Timber doors can be of 35mm solid core in choice of veneers*

Door Frames

- Aluminium full height up to 3000mm, doors are mounted on either hinges, pivot or sliding tracks. A range of Ironmongery can be supplied and incorporated with respected series.

Size Limits

- Designed for installation in areas up to nominal vertical panel size of 3000mm x 1200mm

Finish

- All exposed aluminium sections are anodized aluminium finish with 6463 T6 Grade

Panel finish

- Laminate, Melamine, Whiteboard, Veneer, Vinyl, Powder Coated Steel and Pinnable Fabric. These finishes can be applied in any combination.

Assembly Characteristics

Glazed panels are hung onto a site installed framework of recessed head, side walls and base channels, studs and transoms. Base tracks have a snap in profile for better installation of glass into section using beads made of silicone gel material and choice of junctions available. Assembly jig supplied ensures the speed and accuracy of the installation and correct alignments of panel. All panels can be removed independently of each other allowing replacement or variation at any time after initial installation.

Available in two Colors



* kindly consult Authorised KUBIK person before placing order or confirmation.



CANNA 45

45mm x 25mm (single glaze)

Technical Details

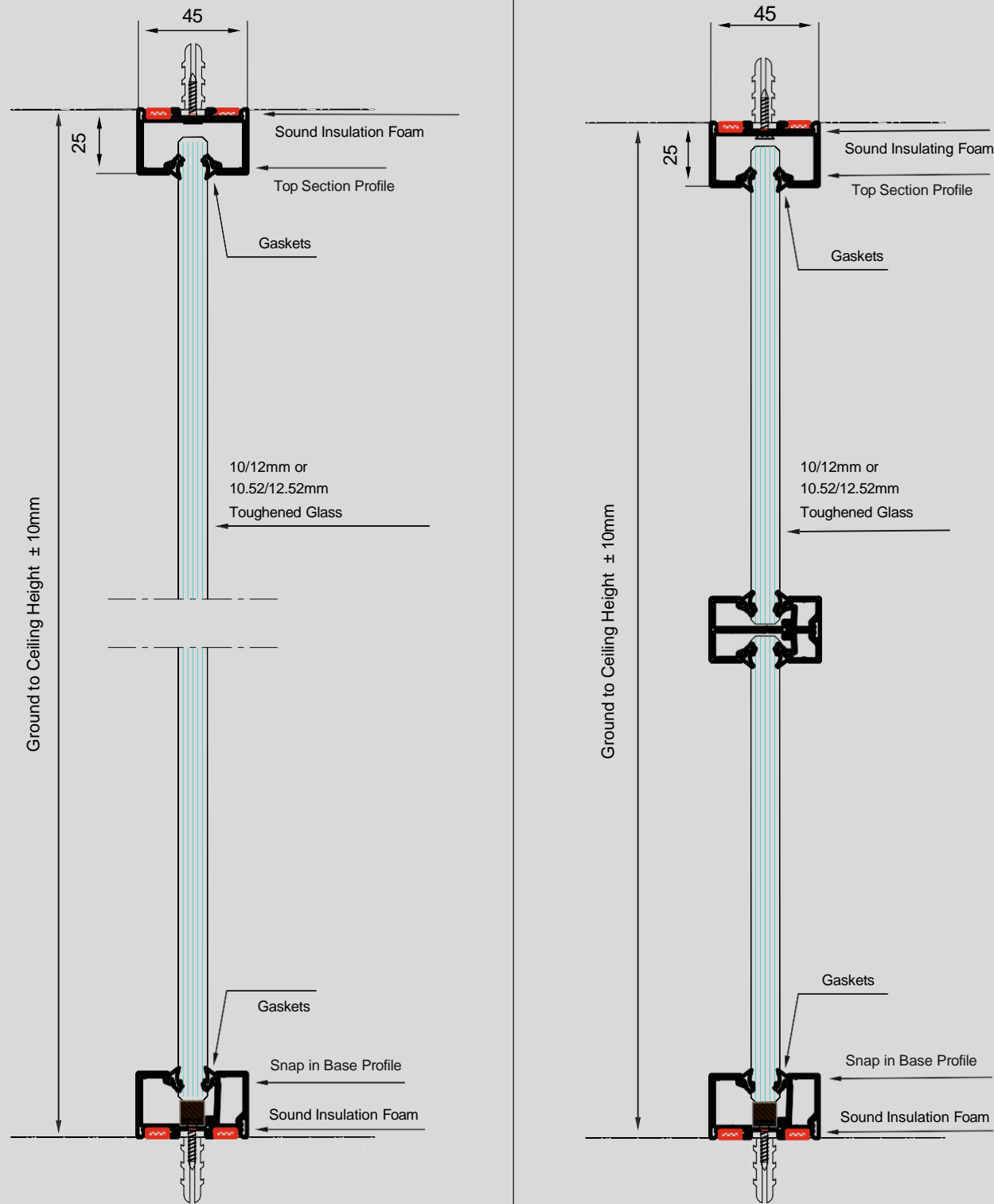

CANNA 45

45mm x 25mm (single glaze)

Sophisticated Architectural Design Options

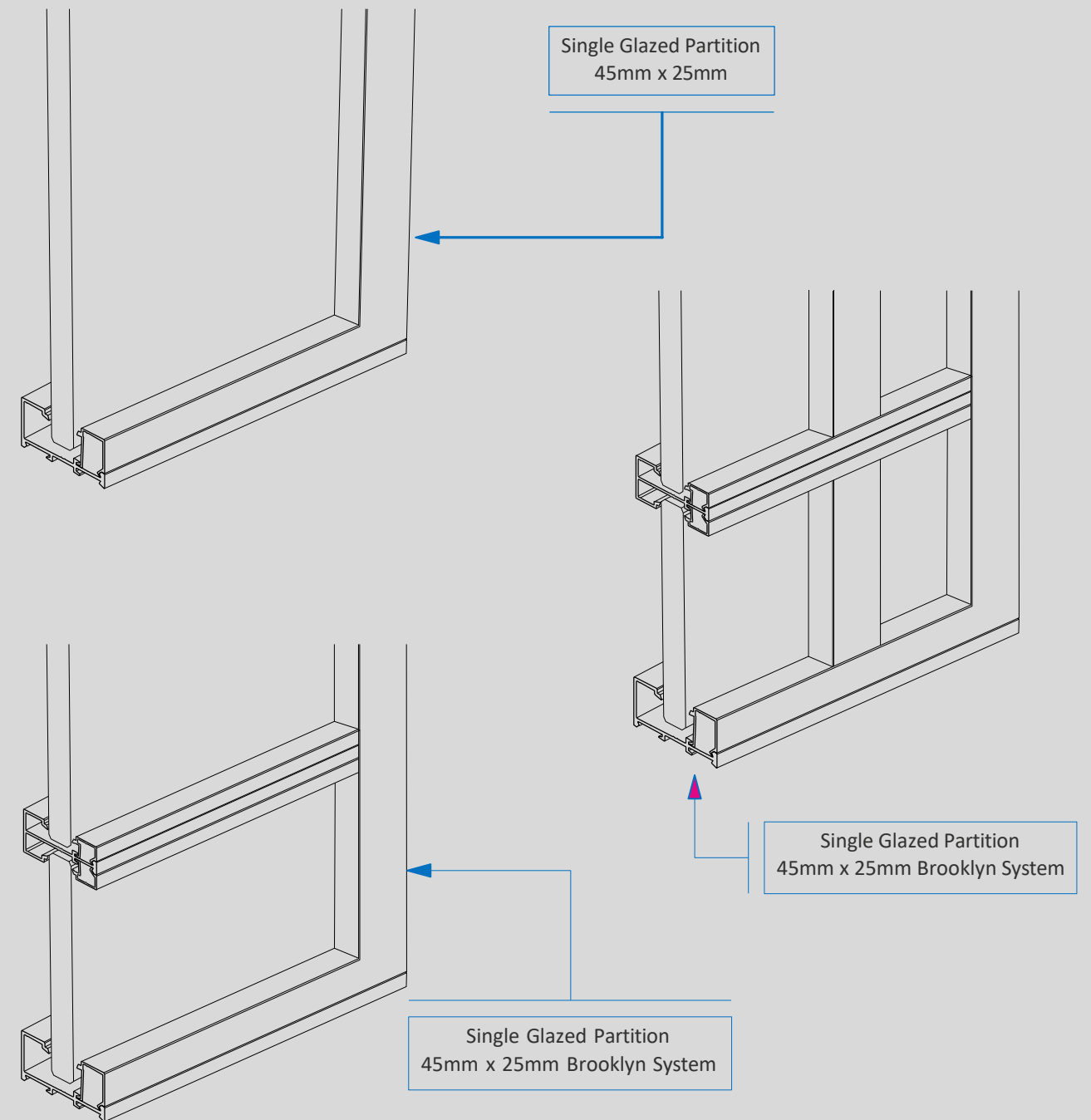

CANNA 45

45mm x 25mm (single glaze)

These are the various options for joining glass at I, L & T junctions

Available in Aluminium as well as transparent plexi dry joints.
Suitable for 10mm / 12mm toughened glass as well as 10.52mm / 12.52mm laminated glass.
The profiles feature a double-sided adhesive tape that guarantee perfect structural union and sound insulation.

Type 1 - Aluminium Joining

I Joint

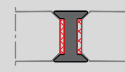

L Joint

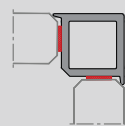

T Joint

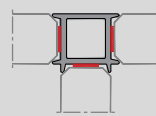

Type 2 - Plexidry Flush Joining

I Joint

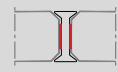

L Joint

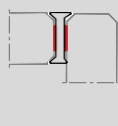

T Joint

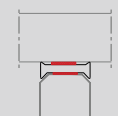

Type 3 - Plexidry Overlap Joining

I Joint



L Joint

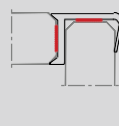

T Joint

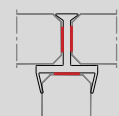

Glass Panels Corner Guard

The panels are connected vertically by transparent polycarbonate profile with in-line, 90 degree and T-shaped joints.

The profiles feature a double-sided adhesive tape that guarantee perfect structural union, sound insulation & safety concerns.

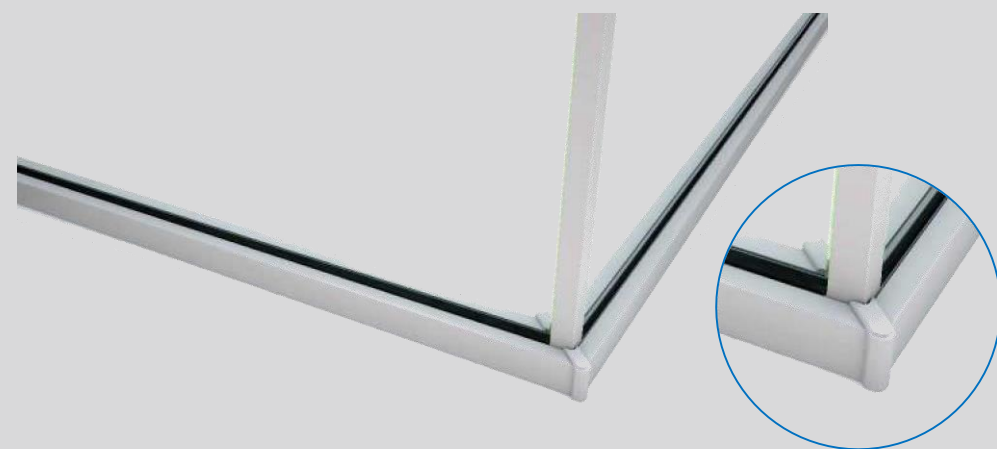

Available in two Colors



CANNA 45

45mm x 25mm (single glaze)



MAPLE 100

MAPLE 100

100mm x 25mm (single glaze)

MAPLE 100

100mm x 25mm (single glaze)

Elegant glass partition for maximum transparency

The SKYHUB MAPLE 100 office partition is another superior range of SKYHUB product that has a proven track record. It is based on a 100mm x 25mm, glazing seal and bead with selection of door frame options.

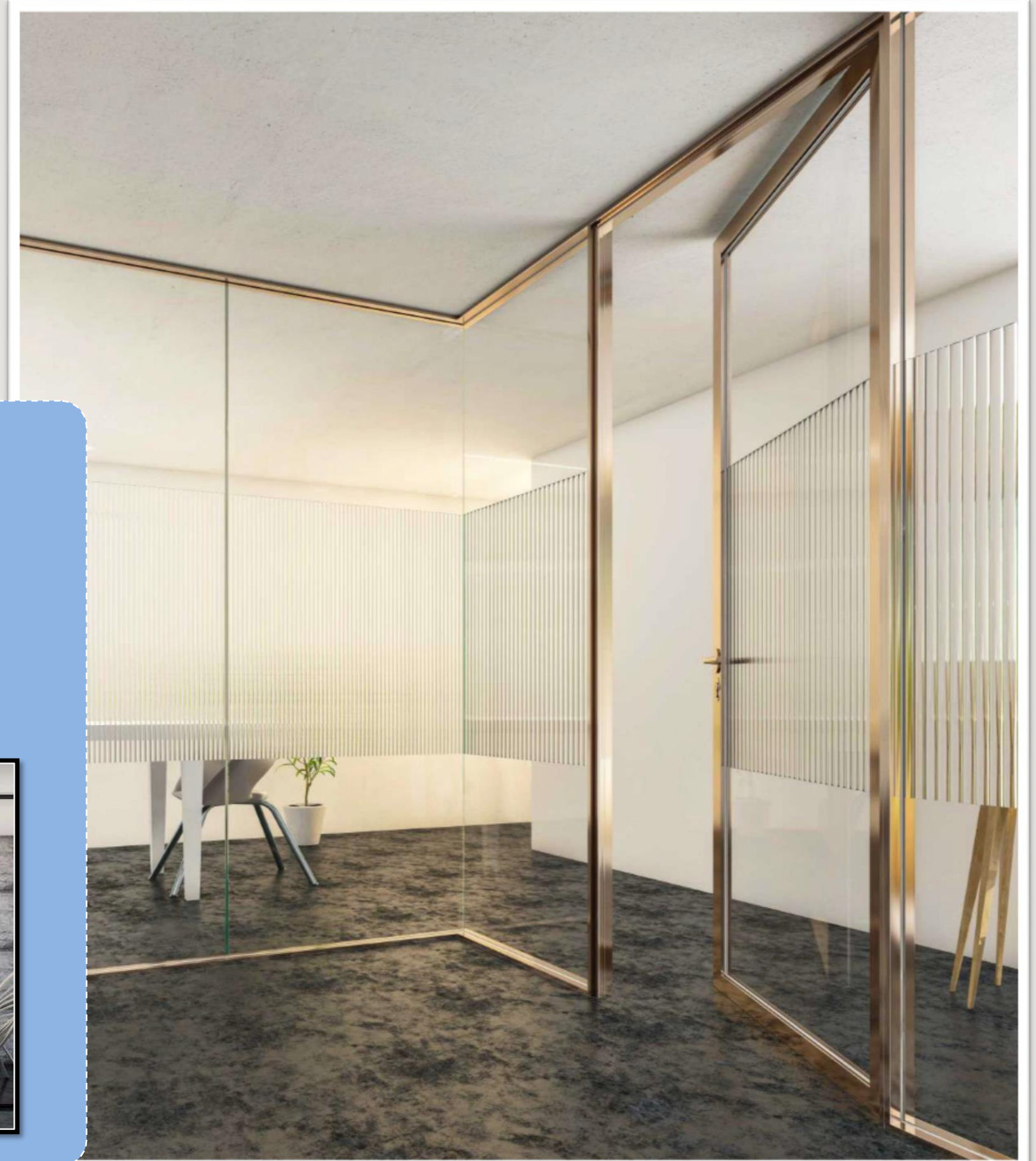

MAPLE 100

100mm x 25mm (single glaze)

Technical Details

Elegant glass partition for maximum transparency

The SKYHUB 100 office partition is another superior range of SKYHUB product that has a proven track record. It is based on a 100mm x 25mm glazing seal and bead with a selection of door frame options.

Features

- Standard track section : 100mm x 25mm
- Slim in design, the standard partition suite can be used with any stud thickness
- Suitable for 10mm / 12mm toughened glass as well as 10.52mm / 12.52mm laminated glass
- Single door frame sizes to allow for flush door 35mm or 45mm
- Partition height can be offered up to 3000mm
- Single glazed systems
- Sound insulation capacity of 32 - 34 dB

Door Options

- Frame less glass, Stile glaze door, Timber or Sliding door system

Solid Doors

- Timber doors can be of 44mm solid core in choice of veneers*

Door Frames

- Aluminium full height up to 3000mm, doors are mounted on either hinges, pivot or sliding tracks. A range of Ironmongery can be supplied and incorporated with respected series.

Size Limits

- Designed for installation in areas up to nominal vertical panel size of 3000mm x 1200mm

Finish

- All exposed aluminium sections are anodized aluminium finish with 6463 T6 Grade

Panel Finish

- Laminate, Melamine, Whiteboard, Veneer, Vinyl, Powder Coated Steel and Pinnable Fabric. These finishes can be applied in any combination.

Assembly Characteristics

Glazed panels are hung onto a site installed framework of recessed head, side walls and base channels, studs and transoms. Base tracks have a snap in profile for better installation of glass into section using beads made of silicone gel material and choice of junctions available. Assembly jig supplied ensures the speed and accuracy of the installation and correct alignments of panel. All panels can be removed independently of each other allowing replacement or variation at any time after initial installation.

Available in two Colors



* kindly consult Authorised KUBIK person before placing order or confirmation.

MAPLE 100

100mm x 25mm (single glaze)



MAPLE 100

100mm x 25mm (single glaze)

Technical Details

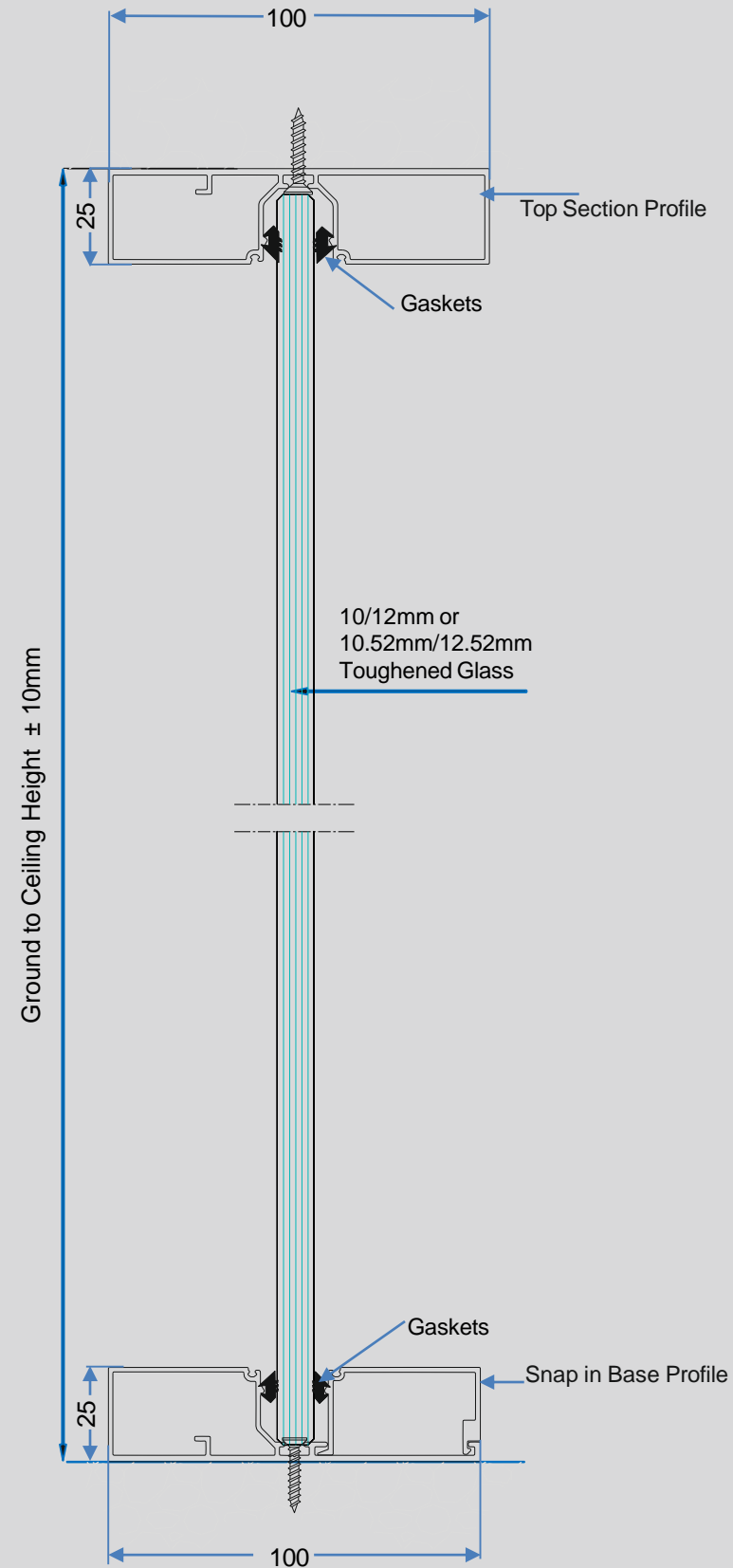

MAPLE 100

100mm x 25mm (single glaze)

Sophisticated Architectural Design Options

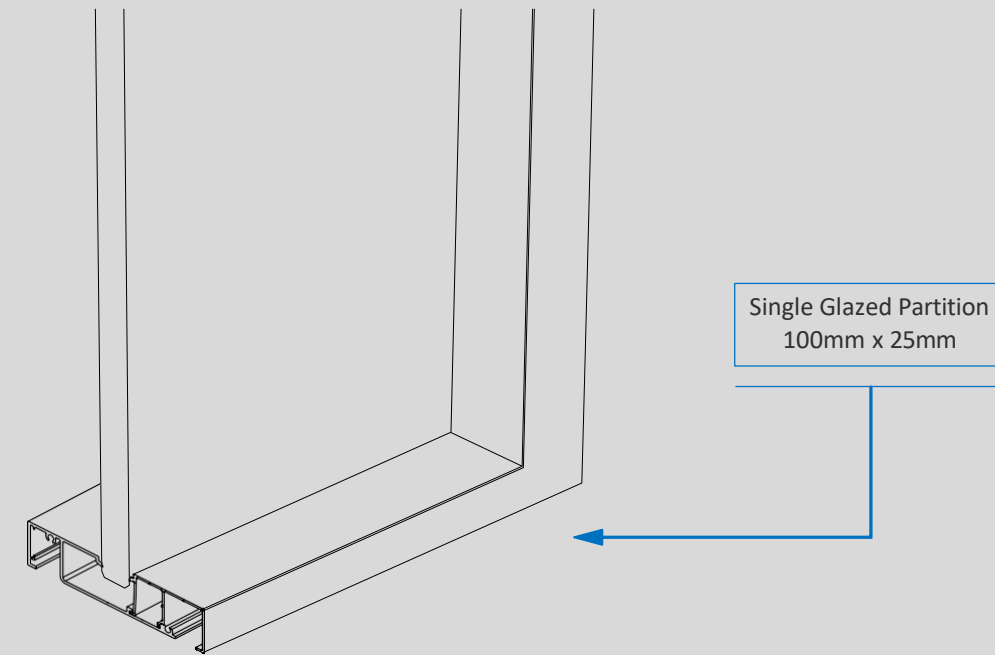

MAPLE 100

100mm x 25mm (single glaze)

MAPLE 100

100mm x 25mm (single glaze)

These are the various options for joining glass at I, L & T junctions

Available in Aluminium as well as transparent plexi dry joints.
Suitable for 10mm / 12mm toughened glass as well as 10.52mm / 12.52mm laminated glass.
The profiles feature a double-sided adhesive tape that guarantee perfect structural union and sound insulation.

Type 1 - Aluminium Joining

I Joint

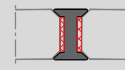

L Joint

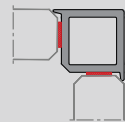

T Joint

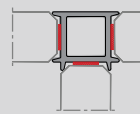

Type 2 - Plexidry Flush Joining

I Joint

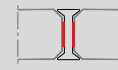

L Joint



T Joint

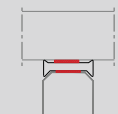

Type 3 - Plexidry Overlap Joining

I Joint

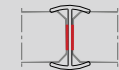

L Joint

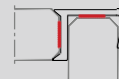

T Joint

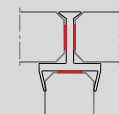

Glass Panels Corner Guard

The panels are connected vertically by transparent polycarbonate profile with in-line, 90 degree and T-shaped joints.

The profiles feature a double-sided adhesive tape that guarantee perfect structural union, sound insulation & safety concerns.

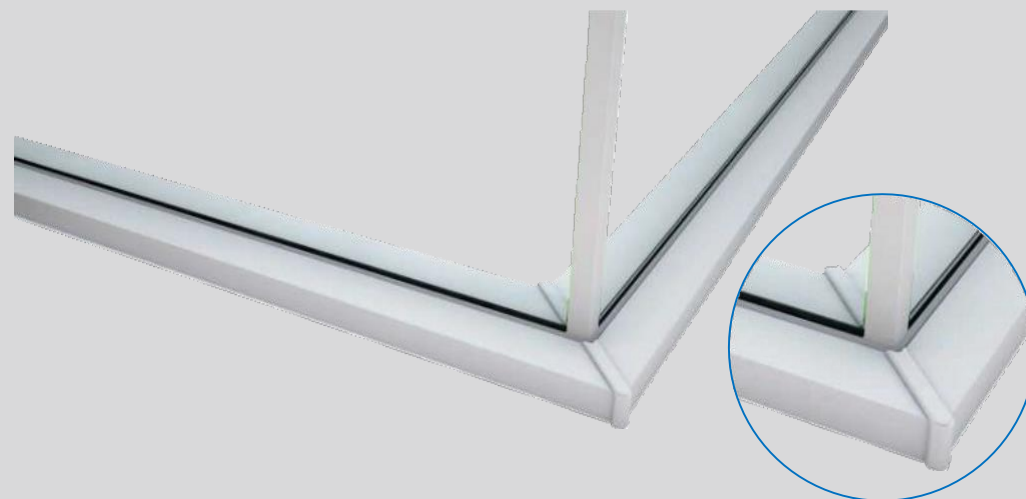

Available in two Colors

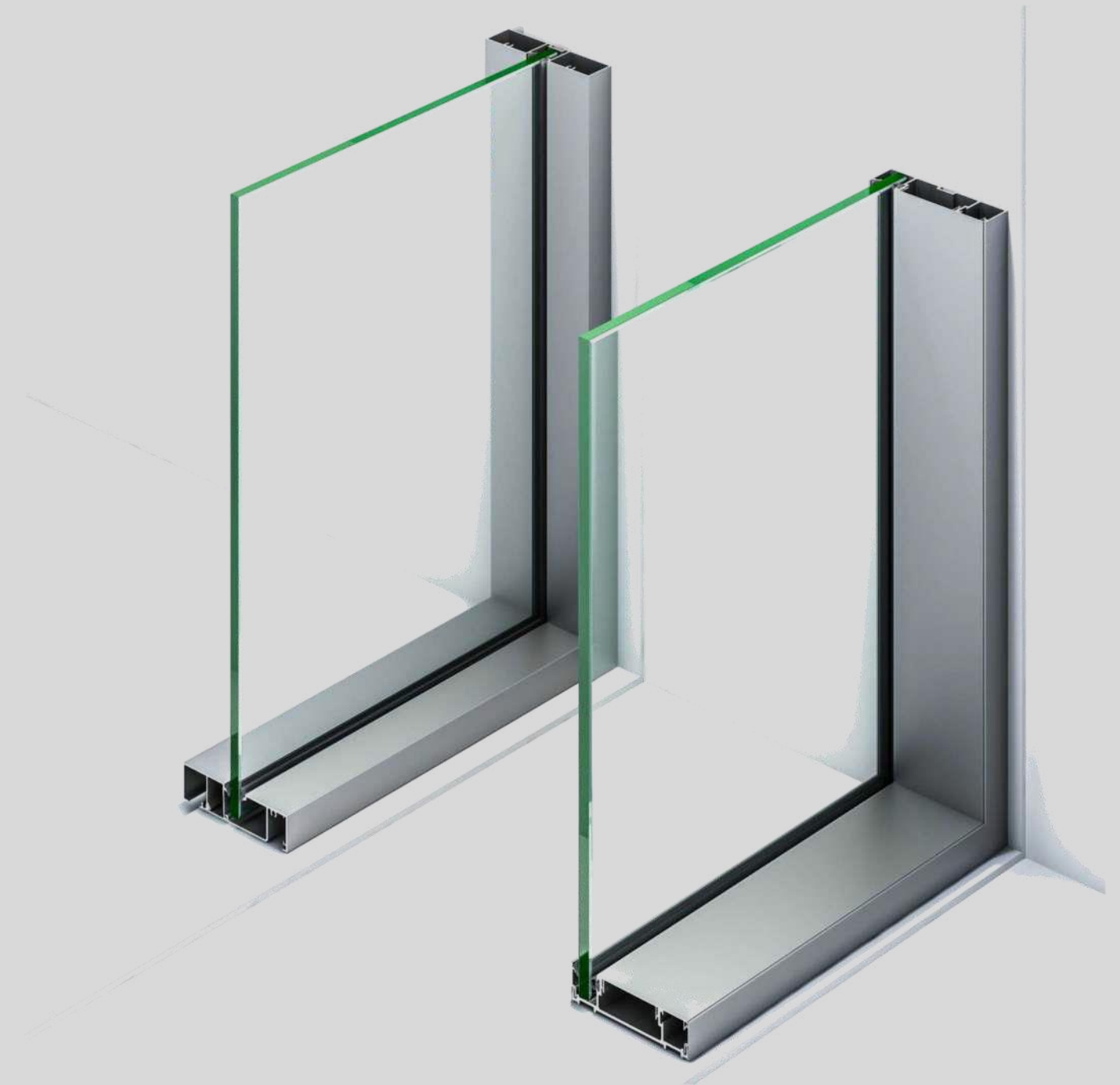

BEL 100 - DG

100mm x 25mm (Double glaze)

Optimum transparency while maintaining privacy

The SKYHUB DG 100 office partition provides excellent acoustic values. It is based on a 100mm x 25mm double glazing seal and bead with selection of door frame options.

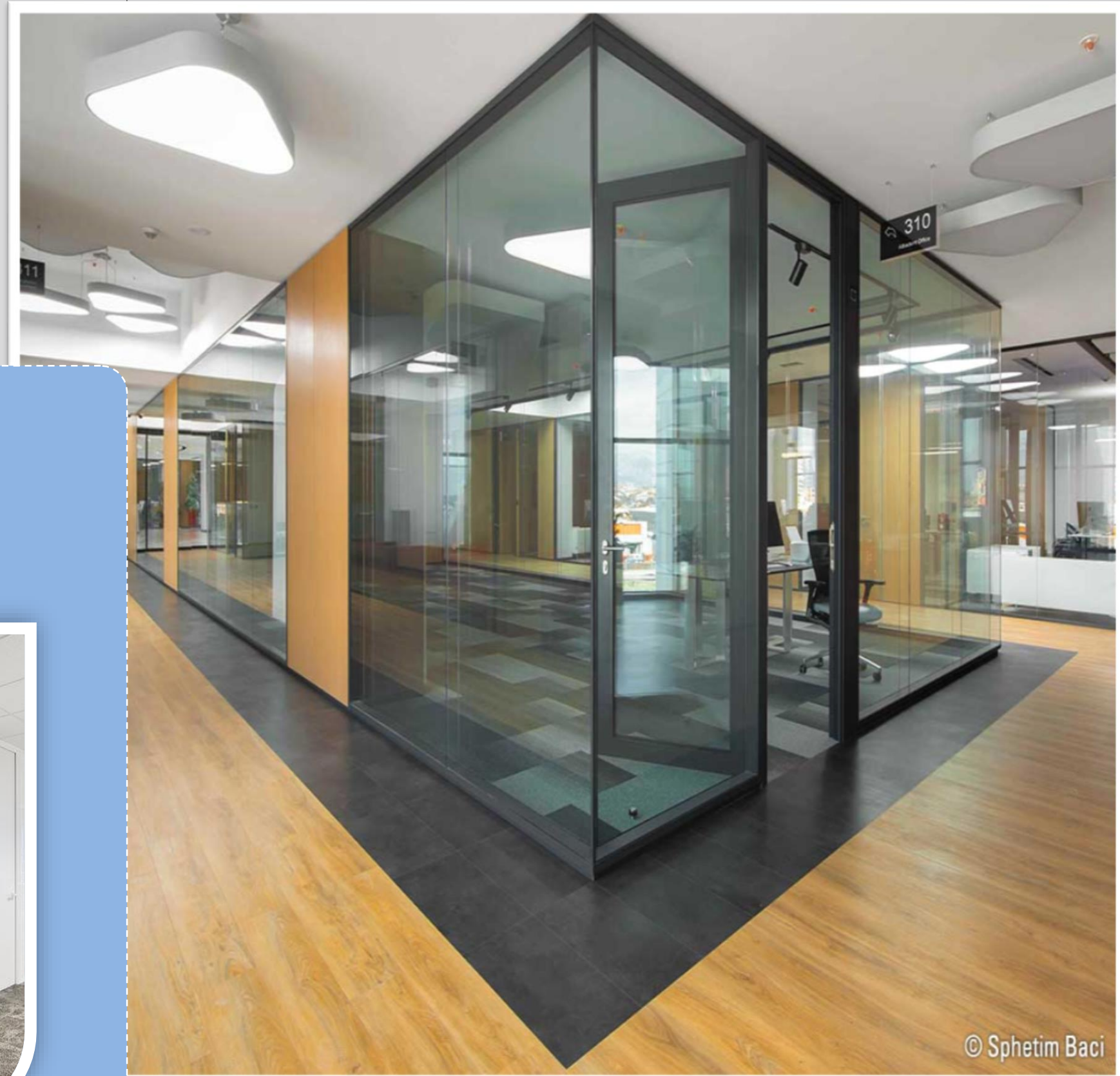

© Sphetim Baci

BEL 100 - DG

100mm x 25mm (Double glaze)

BEL 100 - DG

100mm x 25mm (Double glaze)

Technical Details

Optimum transparency while maintaining privacy

The SKYHUB BEL DG 100 office partition provides excellent acoustic values. It is based on a 100mm x 25mm double glazing seal and bead with a selection of door frame options.

Features

- Standard track section : 100mm x 25mm
- Slim in design, the standard partition suite can be used with any stud thickness
- Suitable for 10mm / 12mm toughened glass as well as 10.52mm / 12.52mm laminated glass
- Single door frame sizes to allow for flush door 35mm or 45mm
- Partition height can be offered up to 3000mm
- Single glazed systems
- Sound insulation capacity of 46 - 49 dB

Door Options

- Frame less glass, Stile glaze door, Timber or Sliding door system

Solid Doors

- Timber doors can be of 44mm solid core in choice of veneers*

Door Frames

- Aluminium full height up to 3000mm, doors are mounted on either hinges, pivot or sliding tracks. A range of Ironmongery can be supplied and incorporated with respected series.

Size Limits

- Designed for installation in areas up to nominal vertical panel size of 3000mm x 1200mm

Finish

- All exposed aluminium sections are anodized aluminium finish with 6463 T6 Grade

Panel Finish

- Laminate, Melamine, Whiteboard, Veneer, Vinyl, Powder Coated Steel and Pinnable Fabric. These finishes can be applied in any combination.

Assembly Characteristics

Glazed panels are hung onto a site installed framework of recessed head, side walls and base channels, studs and transoms. Base tracks have a snap in profile for better installation of glass into section using beads made of silicone gel material and choice of junctions available. Assembly jig supplied ensures the speed and accuracy of the installation and correct alignments of panel. All panels can be removed independently of each other allowing replacement or variation at any time after initial installation.

Available in two Colors



* kindly consult Authorised KUBIK person before placing order or confirmation.



BEL 100 - DG

100mm x 25mm (Double glaze)

Technical Details

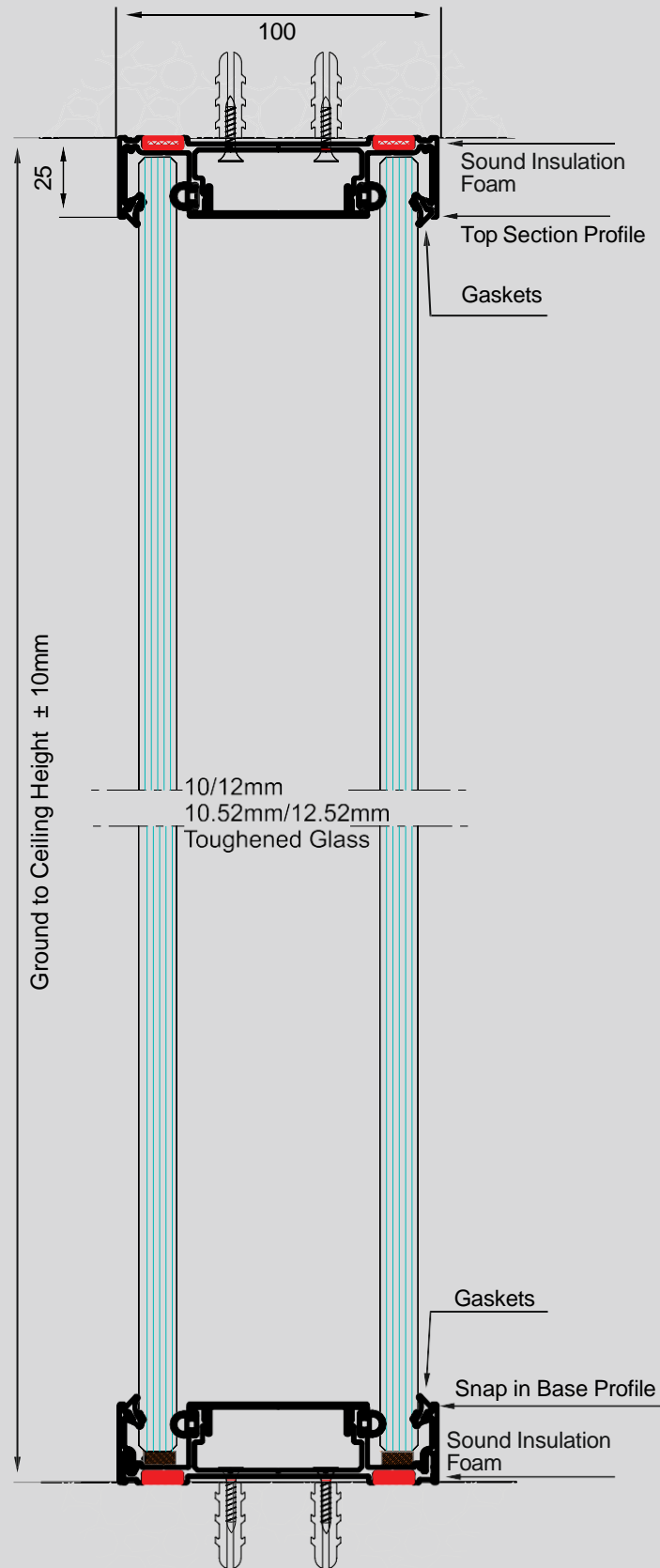

BEL 100 - DG

100mm x 25mm (Double glaze)

Sophisticated Architectural Design Options

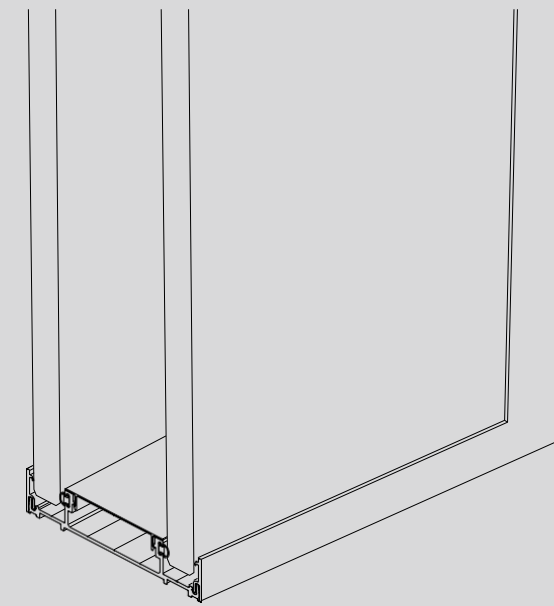

Double Glazed Partition
100mm x 25mm

Double Glazed Partition
100mm x 25mm

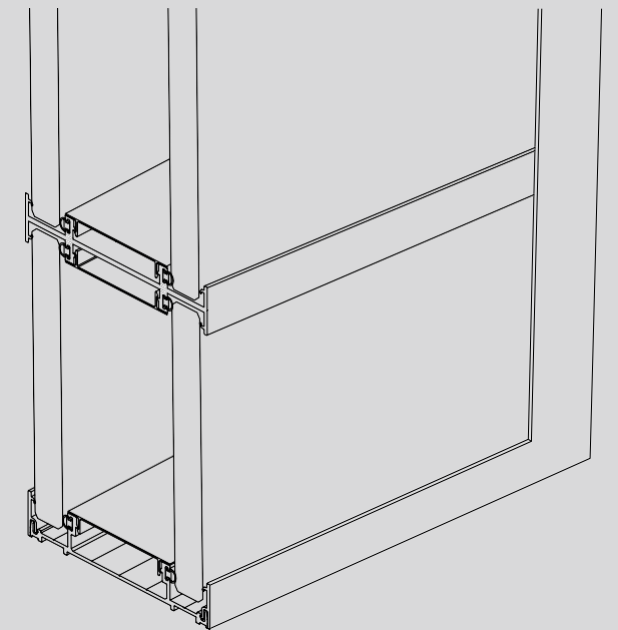

BEL 100 - DG

100mm x 25mm (Double glaze)



These are the various options for joining glass at I, L & T junctions

Available in Aluminium as well as transparent plexi dry joints.
Suitable for 10mm / 12mm toughened glass as well as 10.52mm / 12.52mm laminated glass.
The profiles feature a double-sided adhesive tape that guarantee perfect structural union and sound insulation.

Type 1 - Aluminium Joining

I Joint

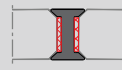

L Joint

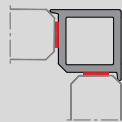

T Joint

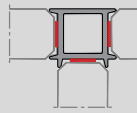

Type 2 - Plexidry Flush Joining

I Joint

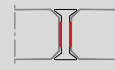

L Joint

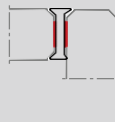

T Joint

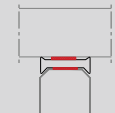

Type 3 - Plexidry Overlap Joining

I Joint

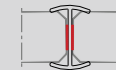

L Joint

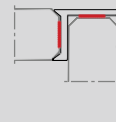

T Joint

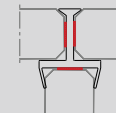

Glass Panels Corner Guard

The panels are connected vertically by transparent polycarbonate profile with in-line, 90 degree and T-shaped joints.

The profiles feature a double-sided adhesive tape that guarantee perfect structural union, sound insulation & safety concerns.

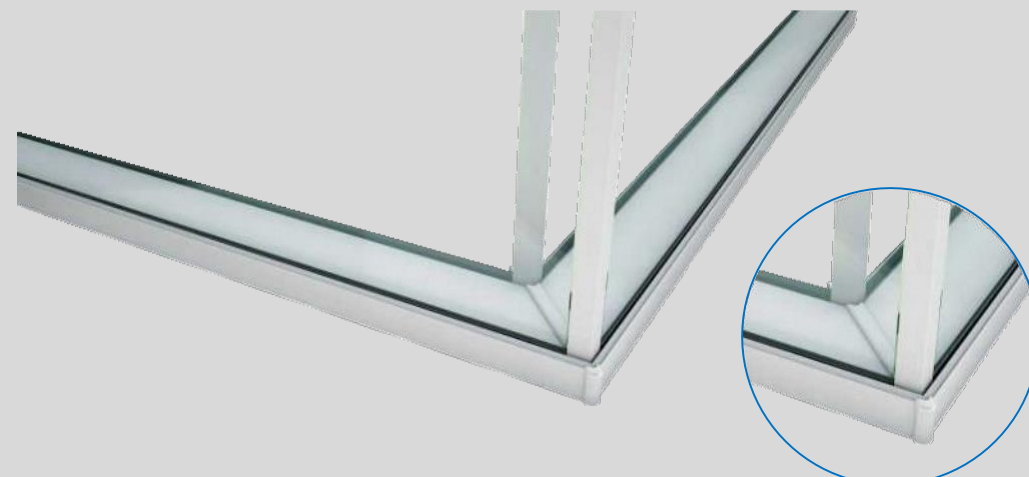

Available in two Colors



BEL 100 - DG

100mm x 25mm (Double glaze)

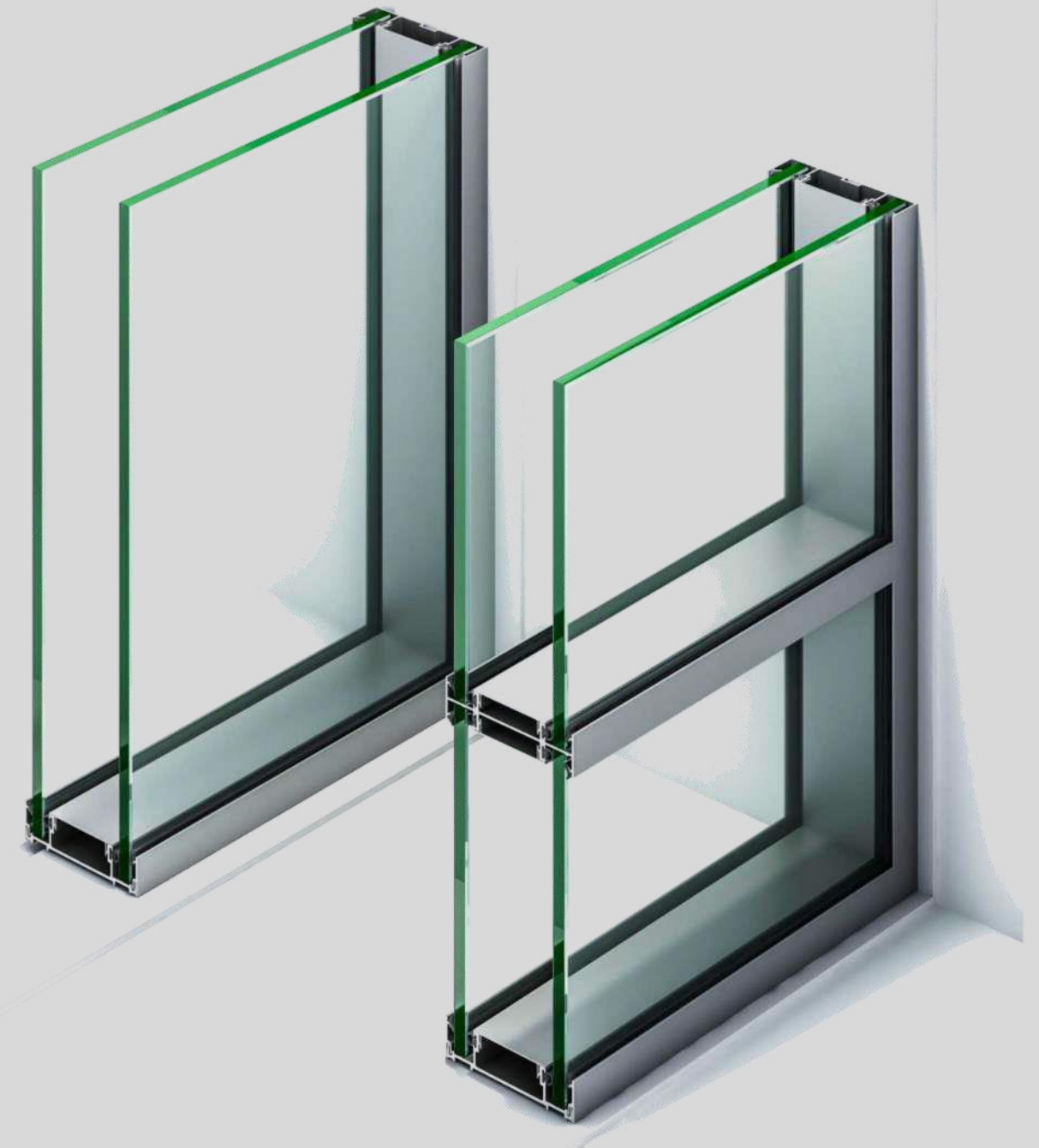



Stile 60

60mm x 35mm

Frame glass door

- Frame glass door - series 60
- various glass type available
- Compatible to European hardware
- Open door closer also applicable
- Suitable at heavy flow of traffic area

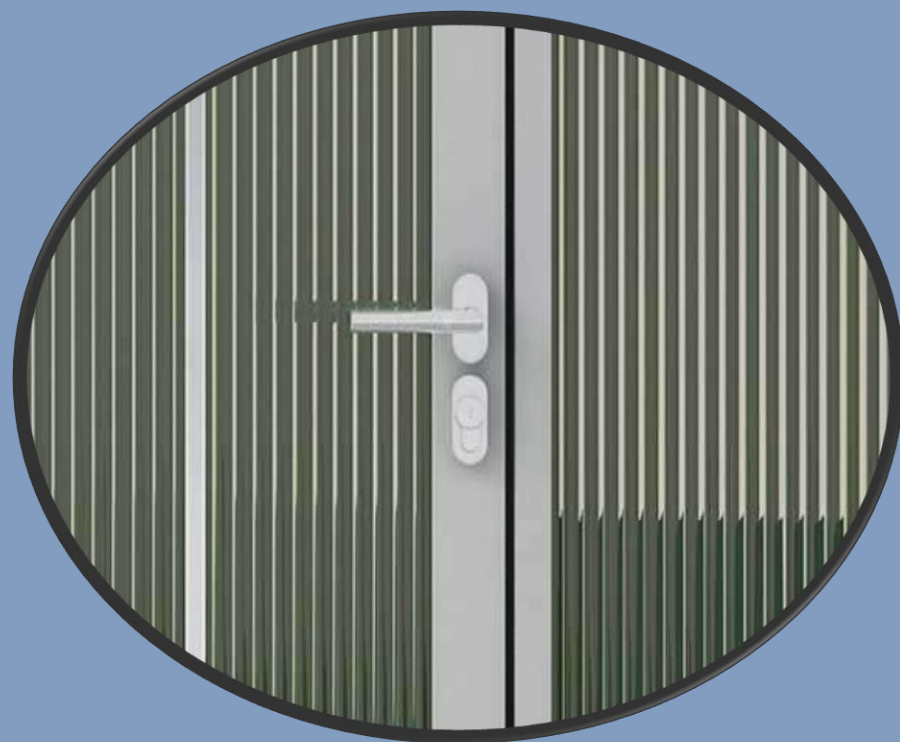

Stile 60

60mm x 35mm



Stile 75

75mm x 45mm

Frame glass door

- Frame glass door - series 75
- various glass type available
- Compatible to European hardware
- Concealed door closer for better aesthetic
- High acoustic level performance



Stile 75

75mm x 45mm





Stickon

RELAXING ATMOSPHERE OFFICE SPACE

Brooklyn series puts a lot of creativity and functionality into its use of glass partition walls, meticulously providing modern industrial look and feel into today's commercial office spaces. Creating unparalleled sense of freedom and space by providing ideal office space solutions.

Applicable on below series:-

SKYHUB 45 series,
SKYHUB 100 series,
SKYHUB DG 100
Series.

For Stile door Application:-

Stile 45,
Stile 60,
Stile 70,

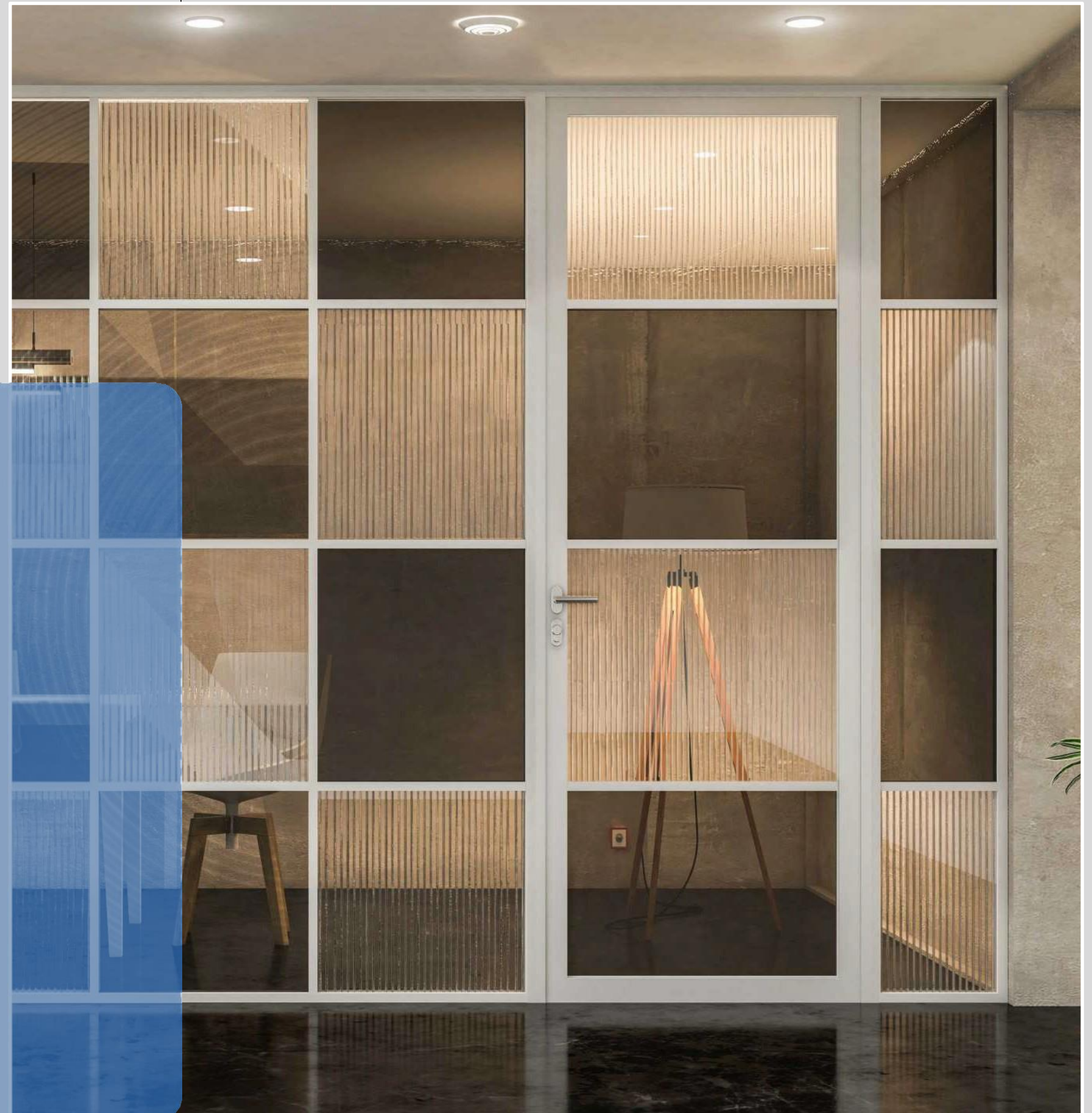

Creating a niche office environment with exclusive designs resembling industrial look n feel, contrasting elements are measured to the finest details making Brooklyn system. This makes it aesthetic as well as modern rich commercial office environment. It comes in two options; one system is integrated divider partition and another with stick on profile, both handled without compromising on quality and acoustic standard.

Stick-on Series Glazing Configuration

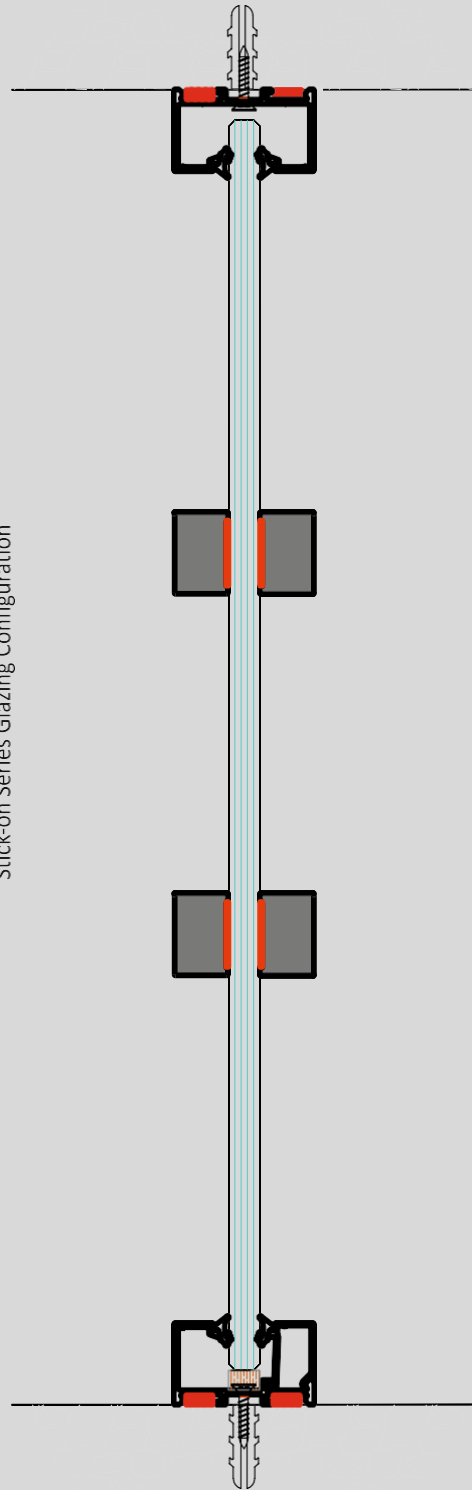

Primarily, SKYHUB offer of panels as standard design assembling, available with existing SHYHUB Demountable Partition series. Apart from these, we can also provide exclusive service for more distinctive designs as and when required by the client..

Panels available are as follows:
45 X 45mm Series
50 X 50 mm Series
100 X 100 mm Series

SKYHUB Tech panels not only provide acoustic values, which strengthen the integrity of the room, but also conceal all power and data cables required for electrical switches / devices, embedded within the Tech panel face.

Ideally, room booking systems are mounted on an adjacent wall outside meeting room, which can be problematic. If the meeting room front is of glass construction, wiring and fixing cables cannot be kept open. With SKYHUB Tech panels, things become easy since all cabling gets concealed within the cavity to meet the aesthetics and usability.

Meeting rooms are mostly occupied for multiple meetings and conference spaces. These SKYHUB Tech panels provide the necessary tools for booking system. This piece of technology allows people to see if a meeting room is available or in use, as well as view the information in meeting scheduler about the meeting which is going to take place in that cabin.

Available with 2 finish : Anodized Aluminum and matt Black, readily available are any given point off the shelf.

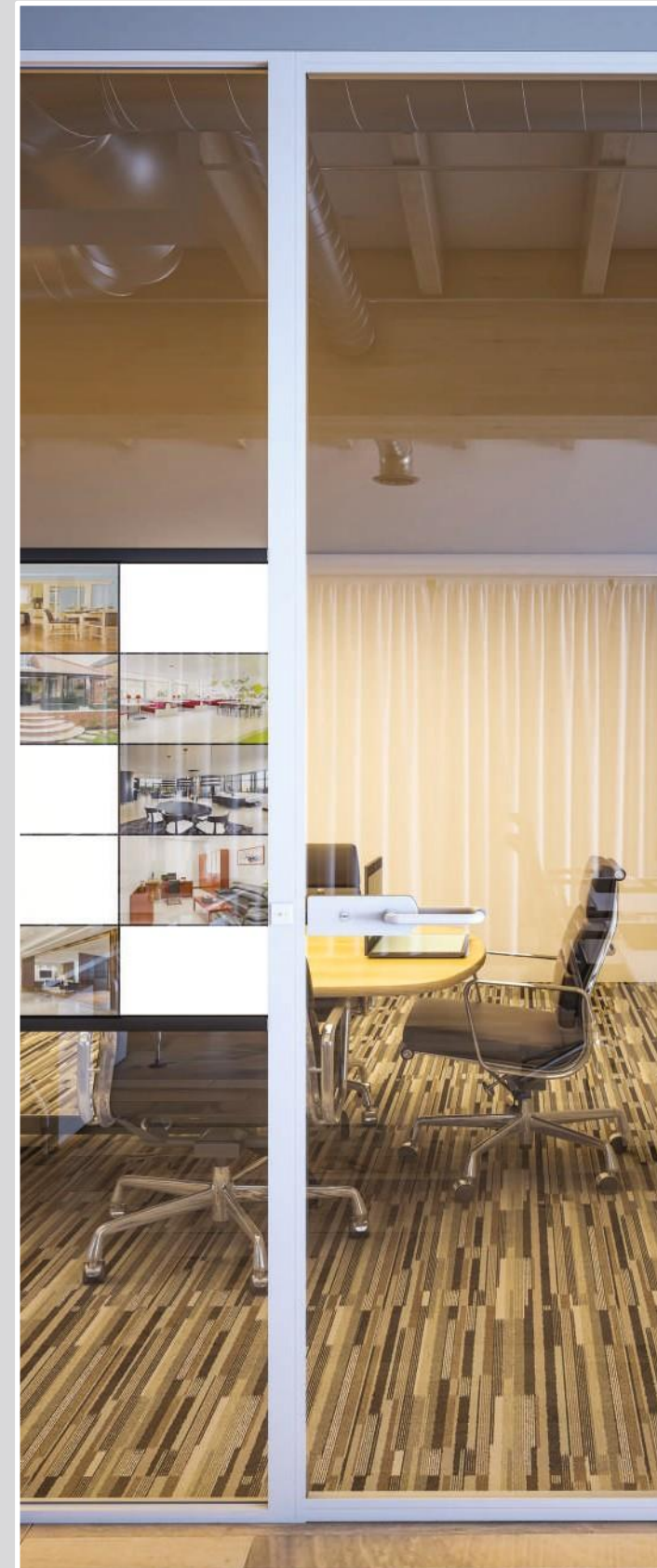

SKY SLIM – 45 - TELESCOPE SYSTEM

45mm x 16mm (Single glaze)

SKY SLIM – 45 Series

Sliding glass doors provide huge space benefit and minimalist design. When combined with proven roller technology, it ensures that even high doors can be operated smoothly and with ease.

The SKYSLIM series, is a superior lightweight profile system. It is based on a 16mm x 45mm glazing seal and bead with a selection of door frame options

Finish

All exposed aluminum sections are anodized aluminum finish with 6063 T6 grade.

Available Finish:



SKY SLIM – 45 – SYNCHRO SYSTEM

45mm x 16mm (Single glaze)

SKY SLIM – 45 Series

Sliding glass doors provide huge space benefit and minimalist design. When combined with proven roller technology, it ensures that even high doors can be operated smoothly and with ease.

The SKYSLIM series, is a superior lightweight profile system. It is based on a 16mm x 45mm glazing seal and bead with a selection of door frame options

Finish

All exposed aluminum sections are anodized aluminum finish with 6063 T6 grade.

Available Finish:



SKY SLIM - 45

SKY SLIM – 45 – SHOWER CUBICLES

45mm x 16mm (Single glaze)

SKY SLIM – 45 Series

Cubical Washroom partition are design to meet The particular need of residences, bungalows Hospitality sectors like hotels.

Cubicles product come in vide range of style, finishes and functions that will compliment and enhance any projects.

Sections size – 45mm X 16mm

Finish

All exposed aluminum sections are anodized aluminum finish with 6063 T6 grade.

Available Finish:

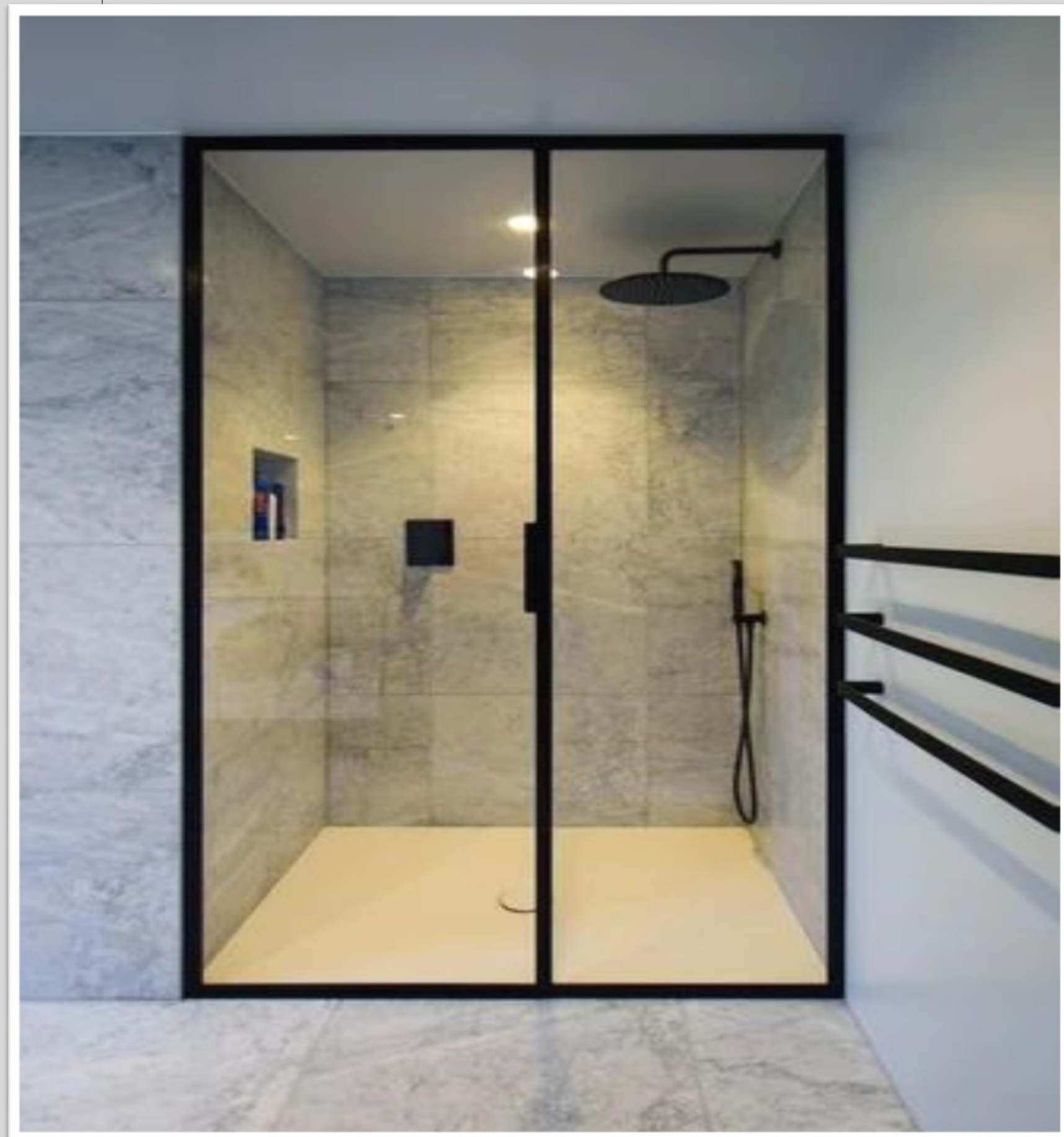

SKYHUB - SKIRTING

SKYHUB – SKIRTING

- Designed to be installed on walls, gypsum and plywood partitions, and on top of all kinds of flooring
- Installed using screws, to camouflage the rivet points
- A capping strip is provided in PVC matching color
- Supplied with protection tap which will be removed after completion
- Height : 50mm / 75mm / 100mm
- Length : 3000mm

Available Finish:



Black Silver

SKYHUB - ACCESSORIES



SKIRTING – 50 / 75 / 100 EASY FIX

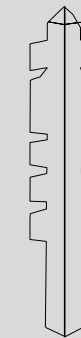

END CAP FOR 50 / 75 / 100 MM SKIRTING

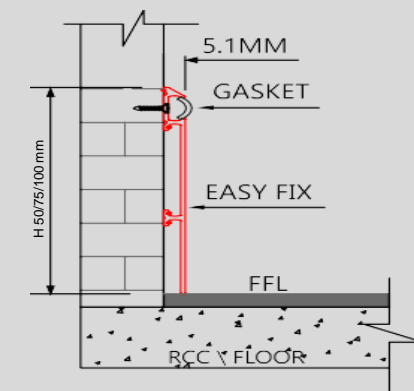

IMPORTANT

Pay attention to the external edges of aluminium skirting. They must be avoided using against agents such as adhesives, sealants and against grinding or scraping actions.

SKYHUB - TRANSITION

SKYHUB – FLEXI 30 - TRANSITION

- Profile can be used as edging for laminate, parquet and hard floors or as a junction to other types of flooring which are variable in heights
- Transition profiles are clipped on to the floor, by inserting specially developed screws and floor plugs in designed holes at random intervals
- No screws visible on top surface, giving it a smooth finish
- Height : 30mm
- Length : 3000mm

Available Finish:



Black Silver

SKYHUB - ACCESSORIES

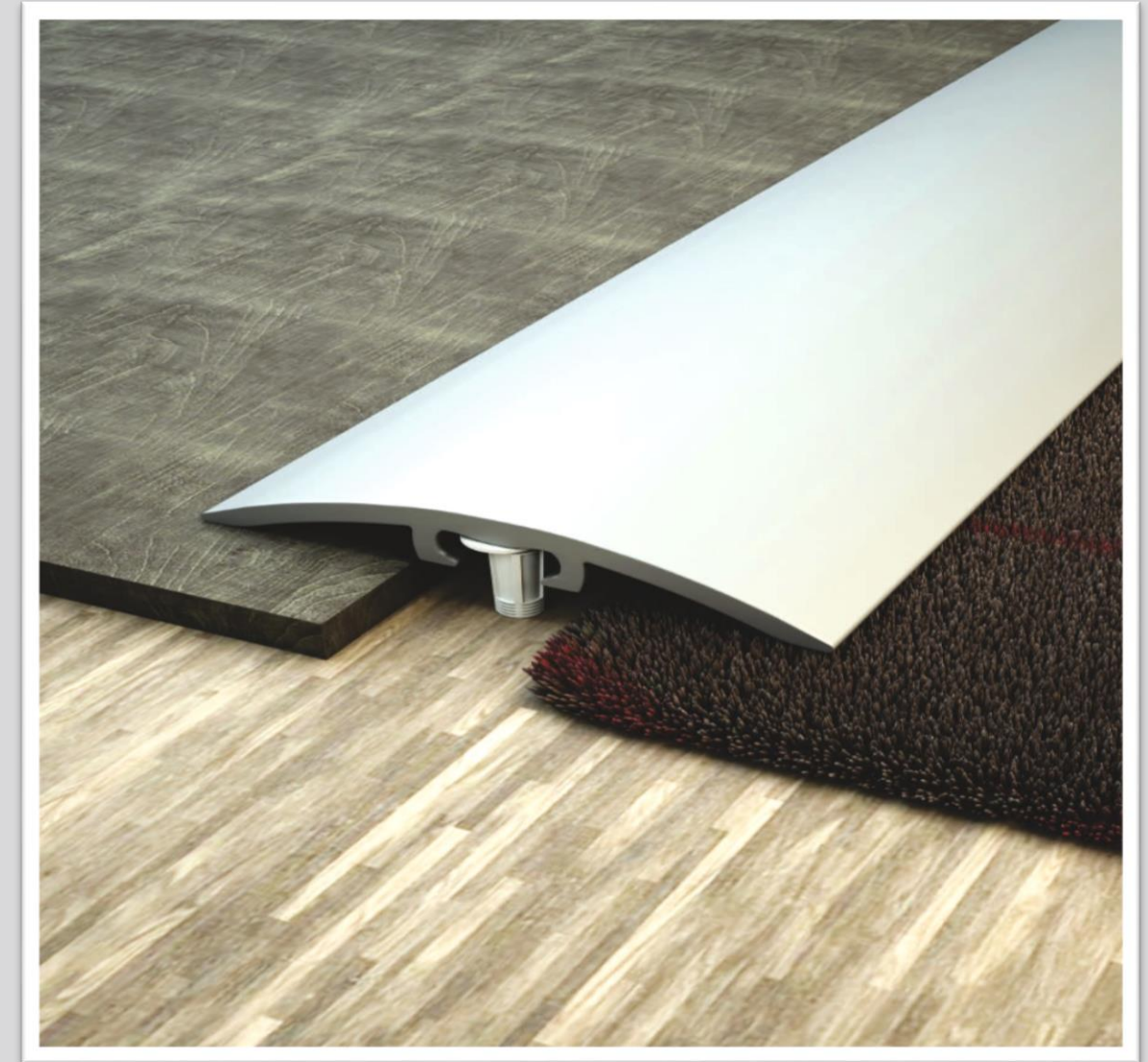

SKY - FLEXI 30 - TRANSITION

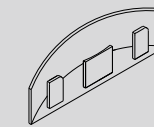

END CAP



NYLON SCREW

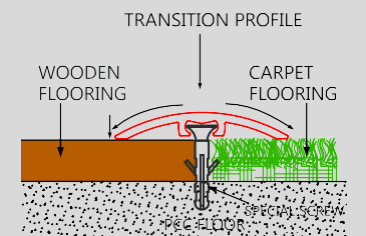

SKYHUB – CORNER GUARD

SKYHUB – CORNER GUARD

- Corner guard provides protection to outside wall corners
- Economical yet durable option for corner protection
- Wings are tapered at the edge for excellent finish
- Available with tape for easy and fast installation
- Width : 12mm x 12mm / 15mm x 15mm / 19mm x 19mm / 25mm x 25mm
- Length : 3000mm

Available Finish:



Black Silver

SKYHUB - ACCESSORIES

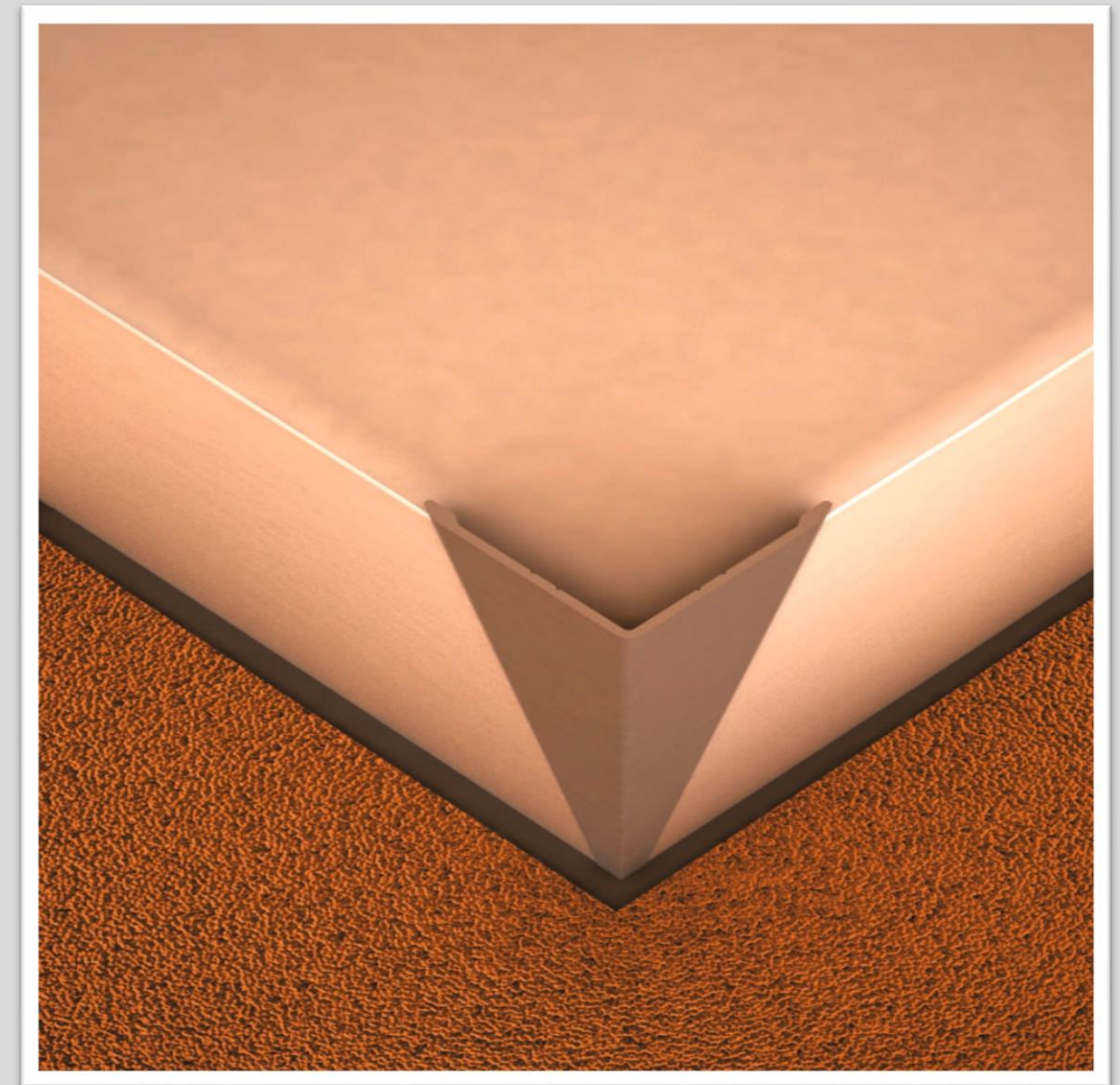

SKY – CORNER GUARD

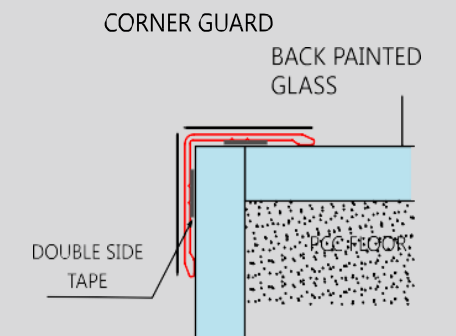

SKYHUB – HAT SECTION

SKYHUB – HAT SECTION

- Decorative profiles are developed to make wall design visually attractive
- Decorative profiles make complex detailing easy
- Protects the corners and edges
- Ideal for junction of two different materials installed on the wall
- Width : 5mm / 8mm / 10mm
- Length : 3000mm

Available Finish:



Black Silver

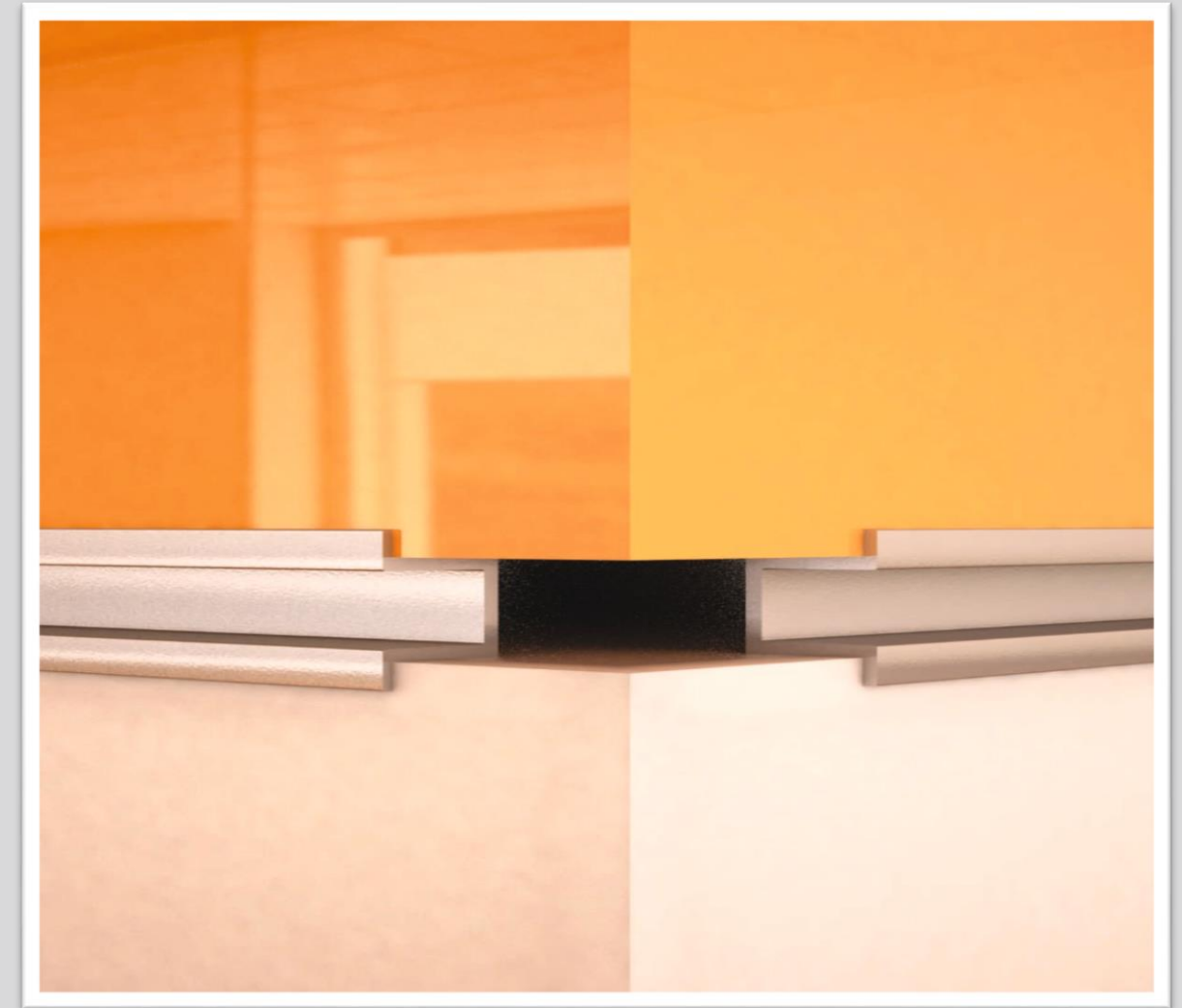

SKY – HAT SECTION

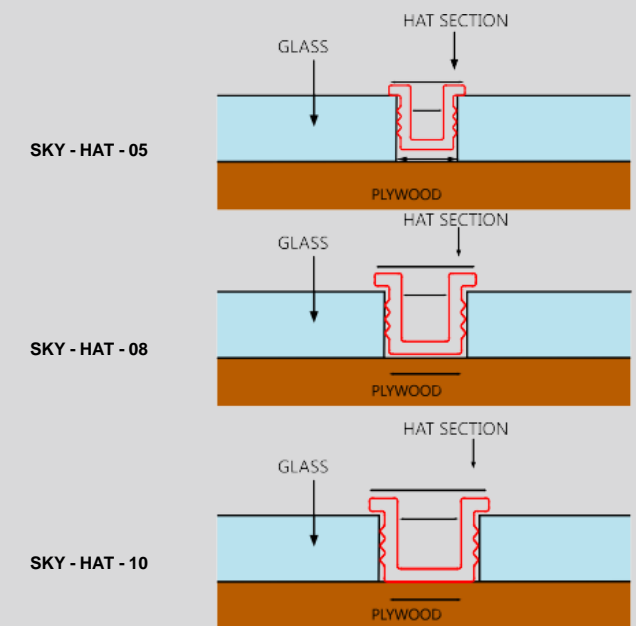



SKYHUB PARTITIONS PVT.LTD.

Office No. 201A & 201B, Trade Corner Building, Near Sakinaka Mtero Station, Saki Vihar Road,
Sakinaka, Andheri (E), Mumbai - 400059, Maharashtra, INDIA.
Website: www.skyhubpartitions.com | Email: info@skyhubpartitions.com
Mobile No. :- +91 91374 83661

